

Processos de Ressurgência

- Definição
- Conseqüências
- Tipos
- Modelo de Ekman
- Ressurgência costeira
- Processos na costa brasileira

Definição

- Processo de ascensão de águas para a superfície do oceano condicionado por efeitos físicos – associado a uma divergência na superfície
 - Alterações em processos físicos, químico, biológicos e geológicos
 - Equação da continuidade

Conseqüências da Ressurgência

- Esfriamento da camada superficial
- Aumento na concentração de nutrientes
- Aumento de produção primária e secundária
- Aumento em taxas de deposição
- Formação de depósitos de fósforo
- Adaptações no esquema de recrutamento de larvas

Tipos

- Ressurgência devida a ventos
 - oceânica – equatorial
 - costeira – margem leste dos oceanos
- Ressurgência de quebra de plataforma
- Ressurgência devida à vórtices ciclônicos
- Ressurgência associada a meandros
- Ressurgências devidas à ondas internas
- Ressurgência devida a efeitos topográficos

Ressurgência Costeira

Coastal Upwelling: Canary Current

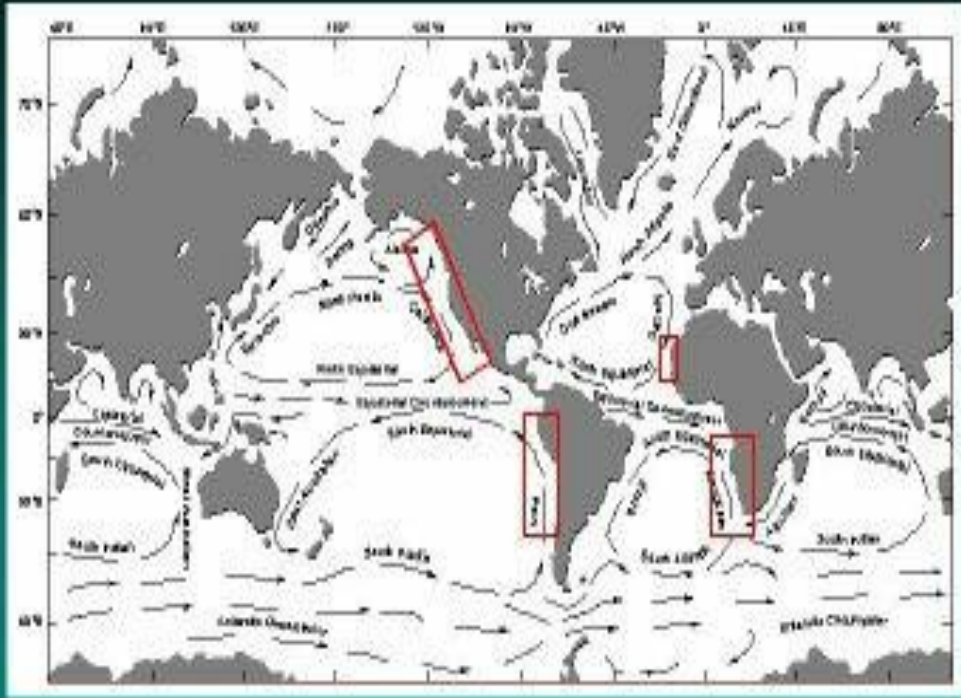

Campo de ventos

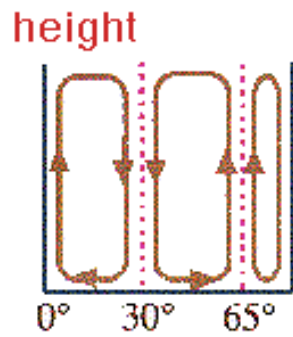
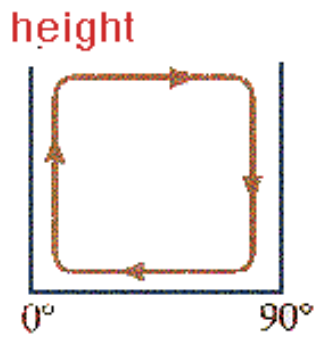
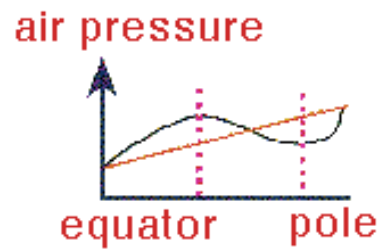
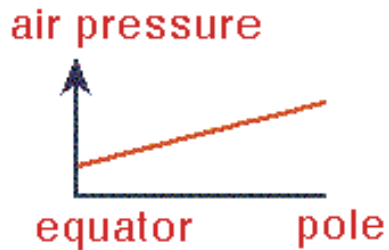

a *no rotation*

b *rotation*

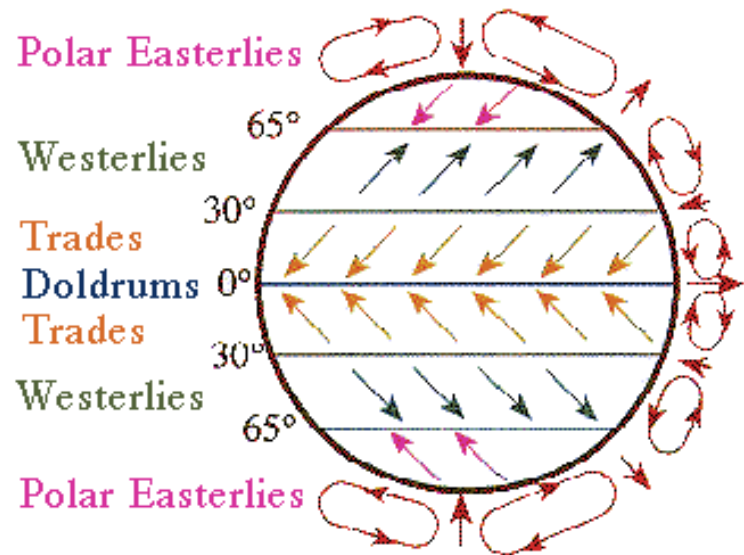

c

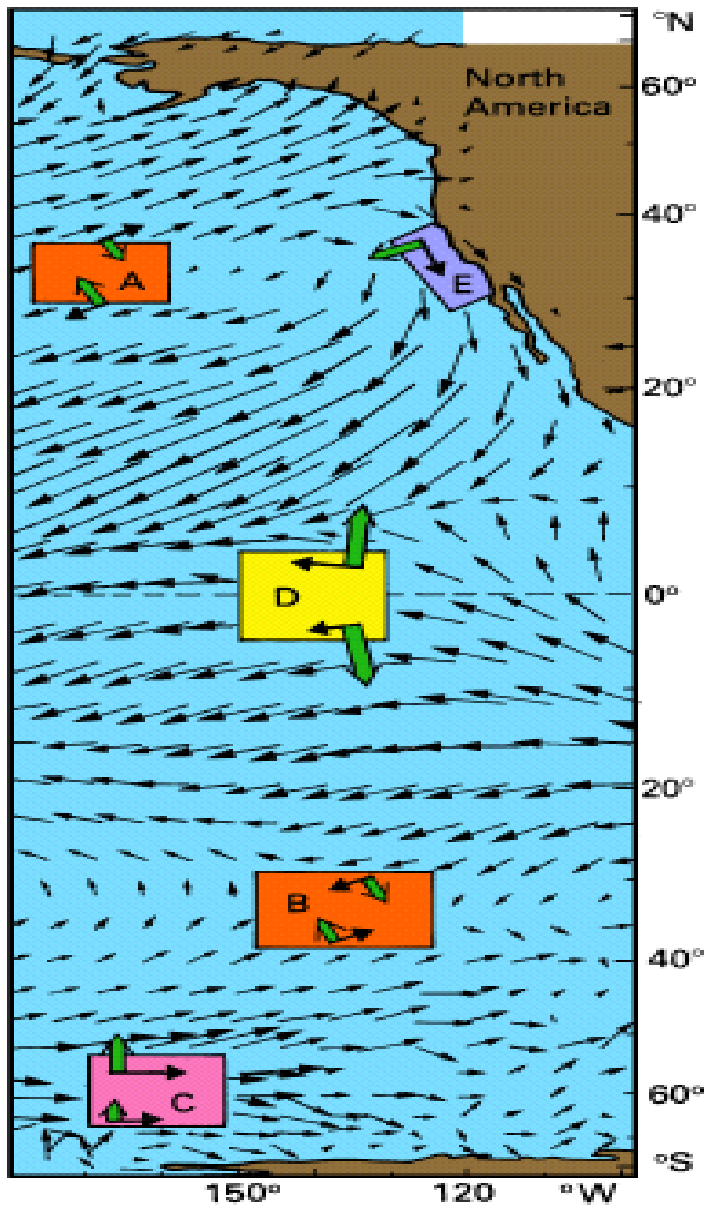

Modelo de Ekman

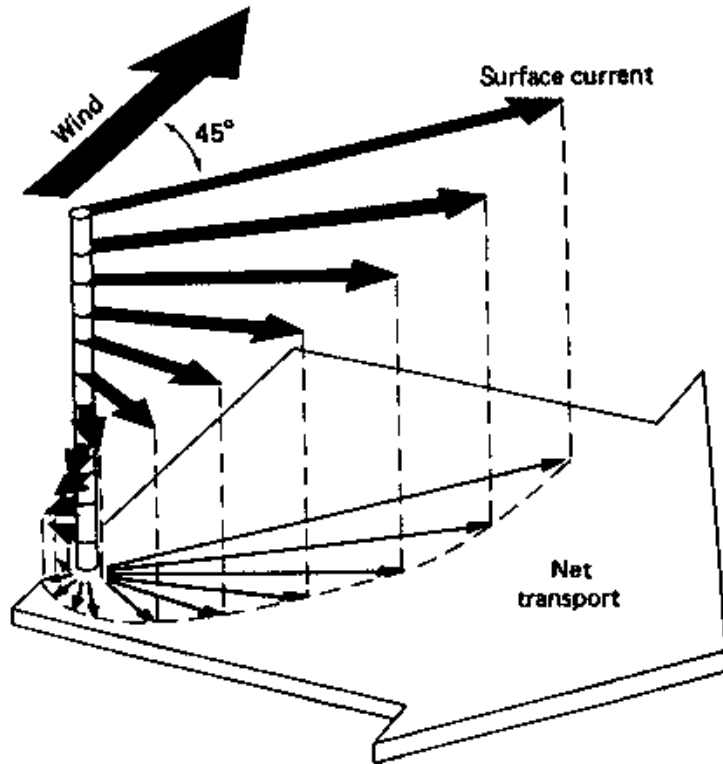

Price et al. 1987. Wind driven ocean currents and Ekman transport. *Science* 238, 1534-1538

Stacey et al. (1986. A wind forced Ekman spiral as a good statistical fit to low-frequency currents in a coastal strait. *Science* 233, 470-472

Modelo de Ekman

- Equilíbrio entre F_{Coriolis} e tensão do vento
- Oceano sem bordas e profundidade ilimitada
- Gradiente de pressão nulo
- Vento constante
- Termo de turbulência constante

f – termo de Coriolis

$$fv = K_z \frac{\partial^2 u}{\partial z^2}$$

K_z Coef. de difusão
turbulenta

$$- 1.3 - 1.5 \times 10^{-3} \text{ m}^2 \text{ s}^{-1}$$

V_0 – velocidade na
superfície

$$fu = -K_z \frac{\partial^2 v}{\partial z^2}$$

D_e – espessura da camada
de Ekman

$$u = + / - V_0 \cos\left(\frac{\pi}{4} + \frac{\pi z}{D_e}\right) \exp\left(-\frac{\pi z}{D_e}\right)$$

W – velocidade do vento

U, v – velocidades em x e
 y

$$v = V_0 \text{sen}\left(\frac{\pi}{4} + \frac{\pi z}{D_e}\right) \exp\left(-\frac{\pi z}{D_e}\right)$$

$$D_e = \frac{4.3W}{\sqrt{\text{sen} |\phi|}}$$

$$V_0 = \frac{0.013W}{\sqrt{\text{sen} |\phi|}}$$

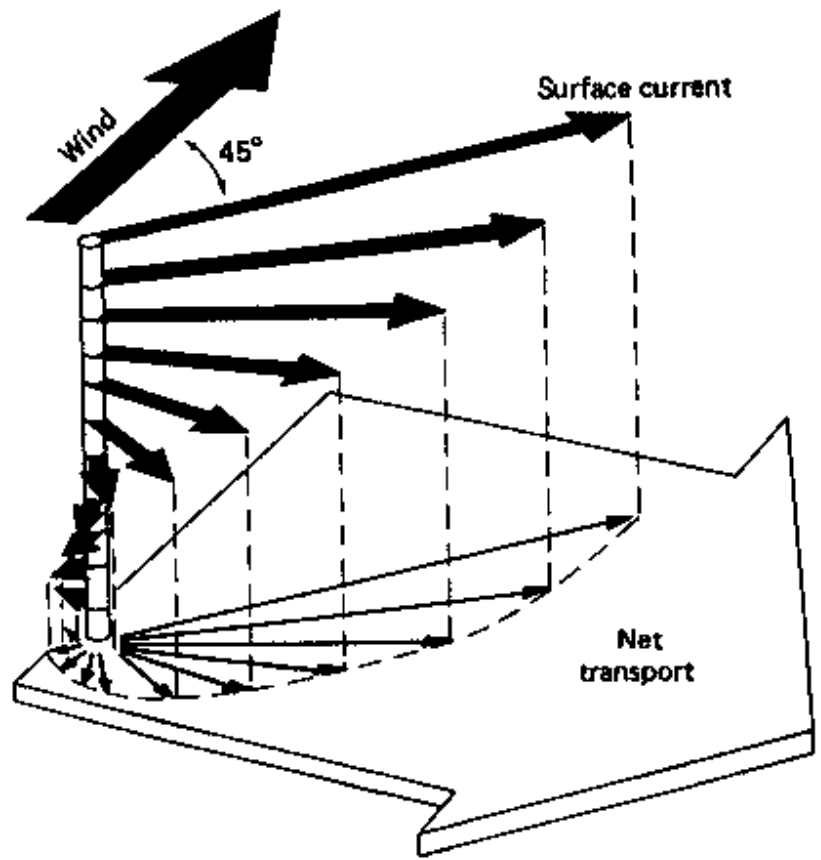

Transporte

$$M_x = \frac{\tau_y}{\rho f}$$

$$M_y = -\frac{\tau_x}{\rho f}$$

$$w_e = \frac{1}{\rho} \left(\frac{\partial \tau_y}{\partial x} - \frac{\partial \tau_x}{\partial y} \right)$$

Rotacional do vento

Ekman pumping

Rot>0 - divergência

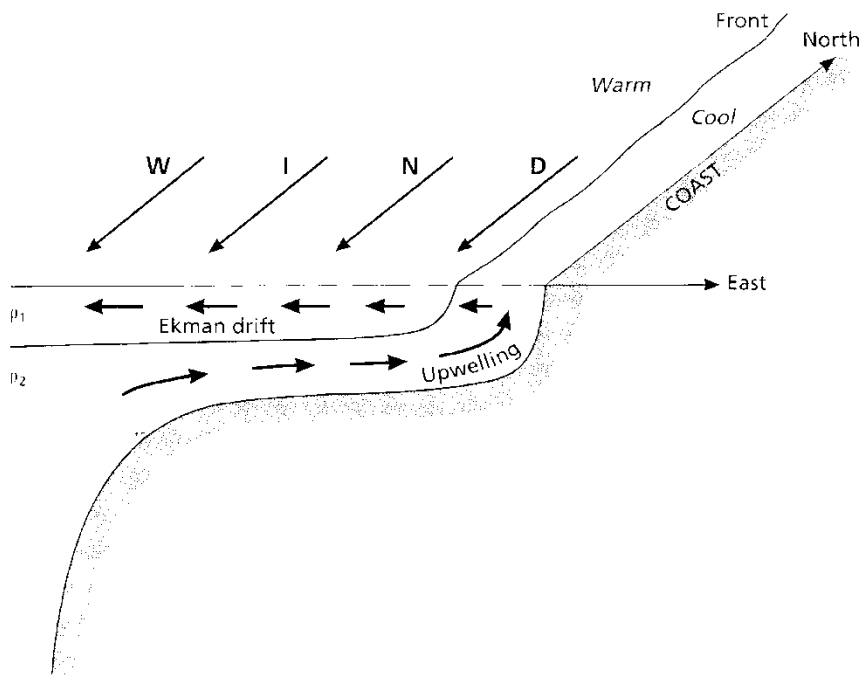

Fig. 5.05 A perspective drawing through an upwelling region illustrating the offshore Ekman drift in the upper layer being replaced near the coast by upward moving water from the lower layer. The upwelling water, usually cool, is separated from the offshore warm water by a surface front parallel to the coast. The wind blows from north to south.

$$M_E = -\frac{\tau}{f}$$

Com:

$$\tau = 0.01 \text{ N/m}^2$$

$$f = 10^{-4} \text{ s}^{-1}$$

$$ME = 1000 \text{ kg m}^{-1} \text{ s}^{-1}$$

1t de água por segundo por metro
ao longo de uma linha paralela ao
vento

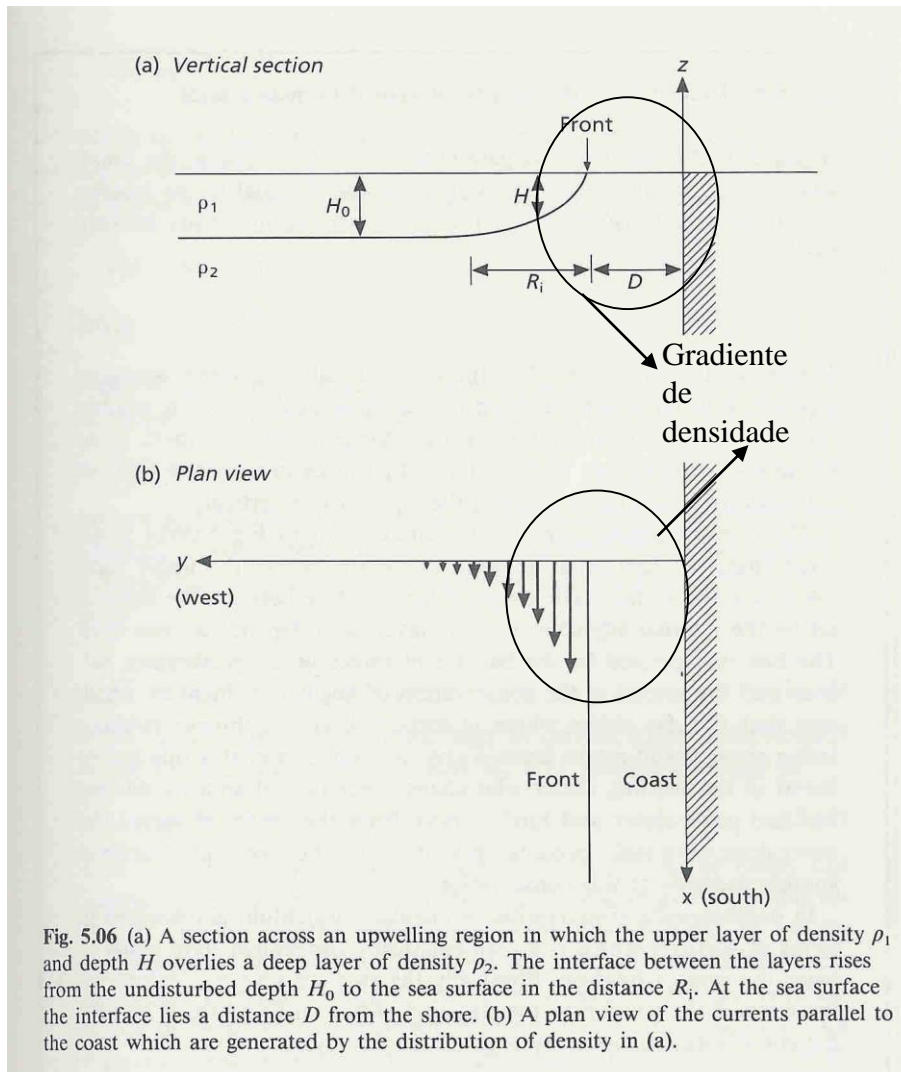

D – distância da frente em relação à costa

R_i – largura da região onde a interface entre a camada superior e inferior (picnoclina) atinge a superfície

Csanady(1981) demonstrou que a após a interface alcançar a superfície ela se move para mar aberto. Uma camada de 20 m de espessura leva 28 h para atingir a superfície com um vento de 7 m s^{-1}

$$R_i = \frac{\sqrt{g' H}}{f}$$

$$g' = \frac{\Delta\rho}{\rho}$$

Hemisfério Sul - Divergência e Convergência Costeira

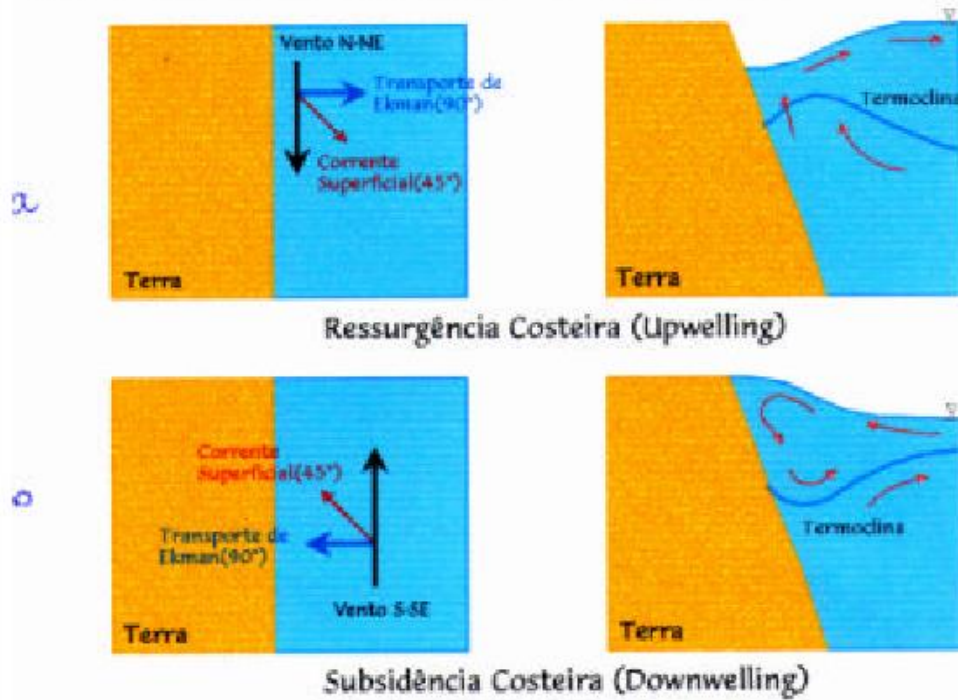

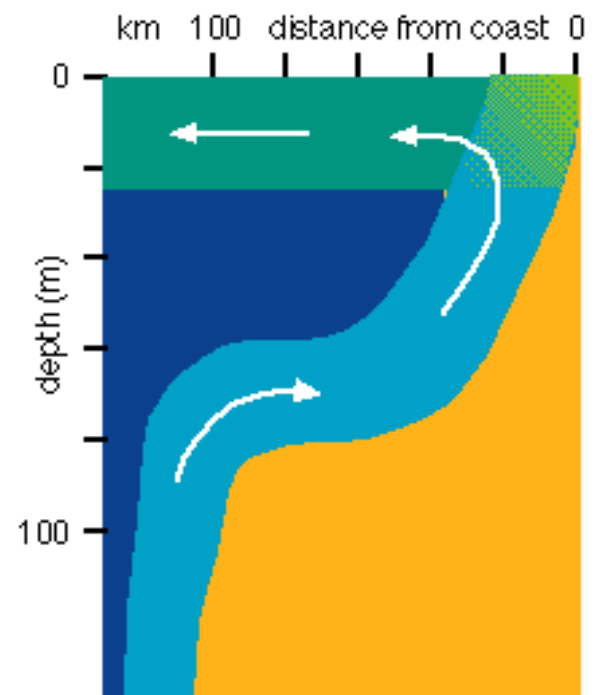
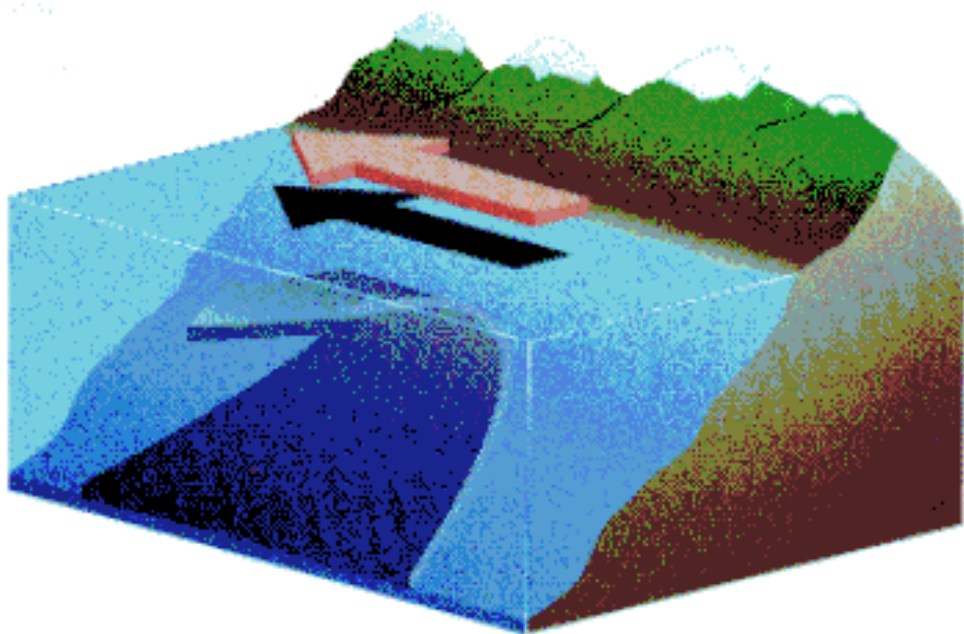

Peru Current Upwelling

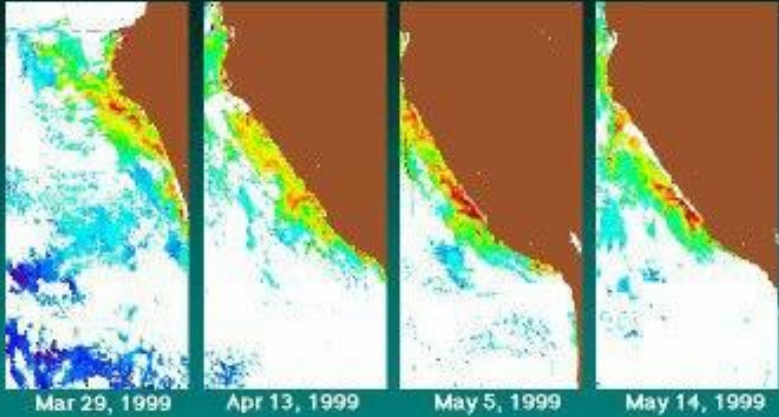

O sistema de ressurgência da costa do Peru/Chile.

(a) Componente longitudinal da velocidade (cm s⁻¹, positivo em direção ao Equador);

(b) componente transversal da corrente (cm s⁻¹, positivo em direção à costa), o transporte de Ekman para mar aberto é indicado por valores negativos na superfície;

(c) temperatura média (°C);

Dados cobrem o período de 22/3 - 10/5/1977.

(d) Temperatura superficial 20 - 23/3/1977. From Brink *et al.* (1983).

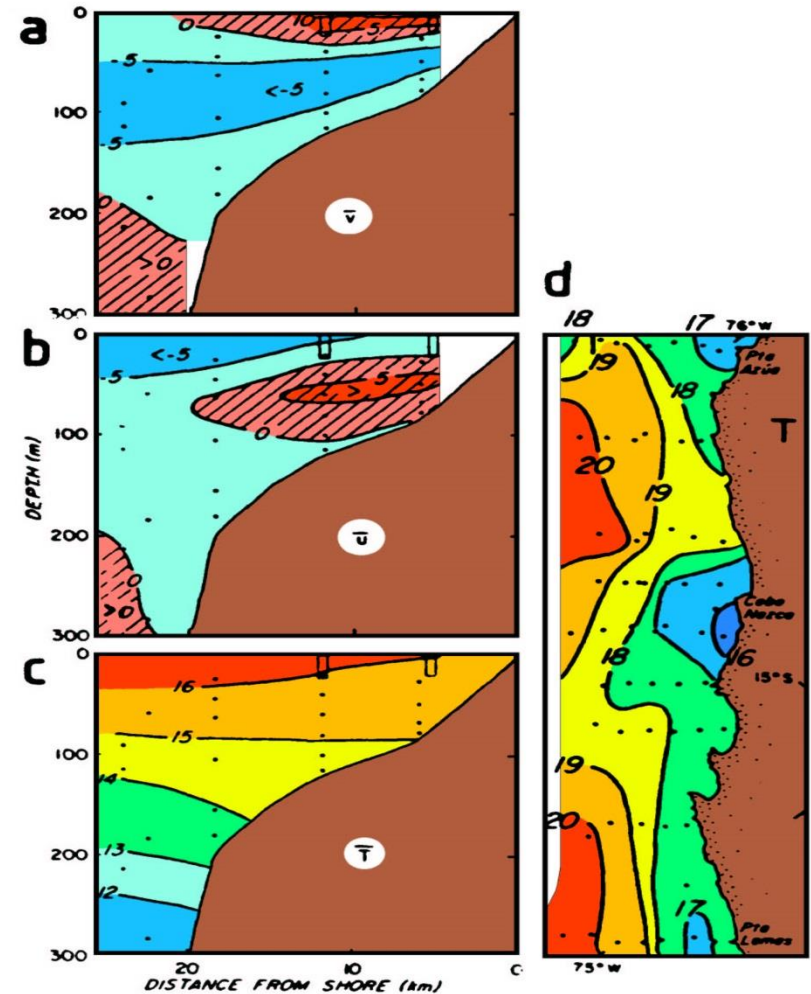

California Current Upwelling

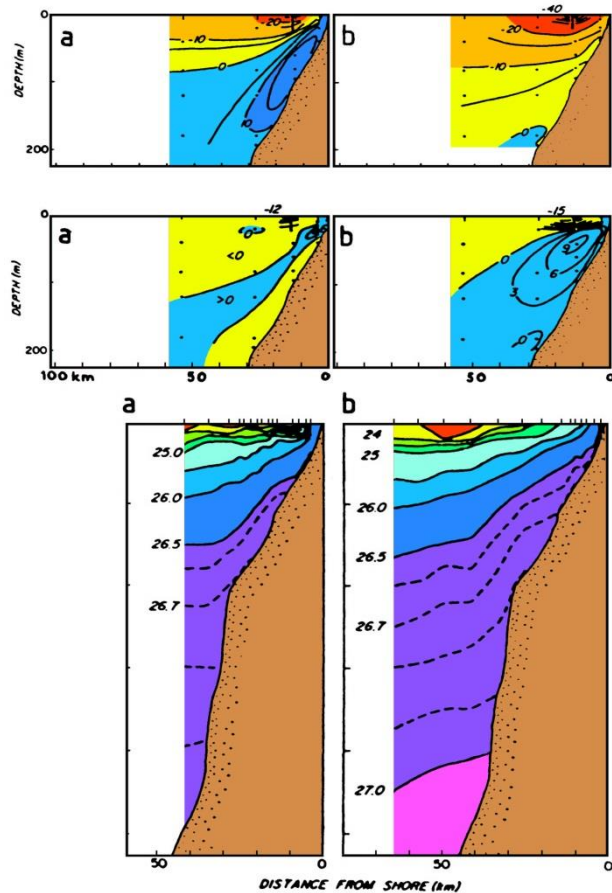
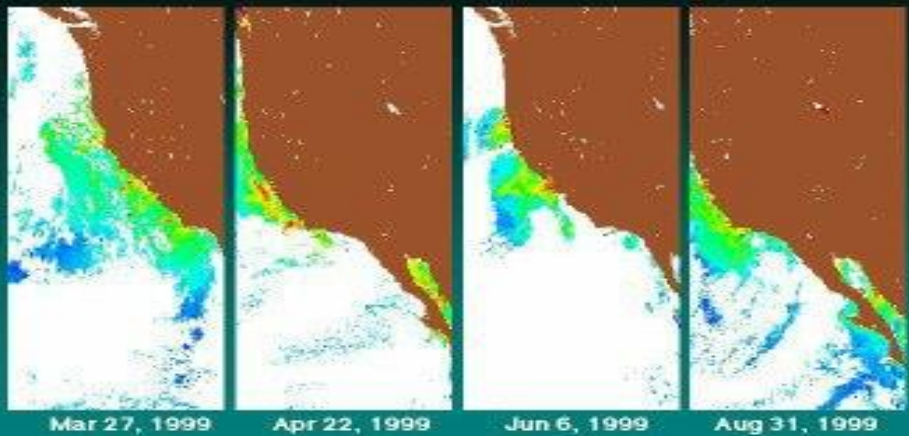

Alongshore flow v (top; cm s⁻¹, positive is poleward), cross-shelf flow u (middle; cm s⁻¹, positive is shoreward), and density σ_t (bottom) in the Californian upwelling system.

Left: During weak wind conditions, right: during strong wind conditions. Intensification of upwelling during strong winds is indicated by an increase in u and an increase in equatorward flow accompanied by a reduced undercurrent. The shallow pycnocline (near $\sigma_t = 24.5$) breaks the surface, forming a front some 20 km offshore during periods of strong upwelling; when the wind relaxes this front recedes towards the coast and may eventually disappear. From Huyer (1976).

El Niño conditions had two direct effects on nutrient supply: (1) reduced upwelling resulted in severe nitrogen limitation during the normal upwelling season; and (2) enhanced poleward movement of warm, high salinity water resulted in anomalously low N:P ratios in the halocline. The latter effect contributed to nitrate limitation during the El Niño spring.

Resurgência na costa da Somália

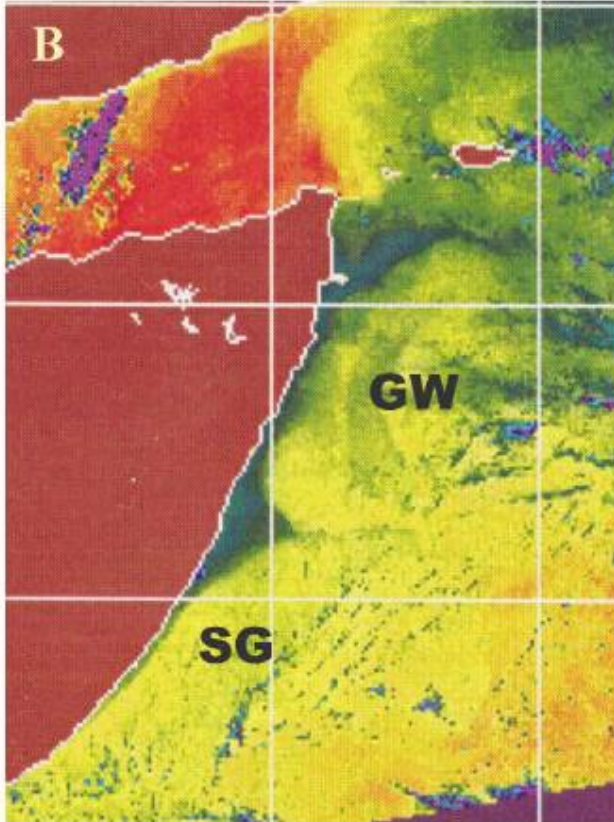

80% da deposição de *Thalassionema nitzschioides* e 78% da deposição de *Chaetoceros* ocorreu durante o período de ressurgência.

Como estas duas espécies são dominantes na assembléia de diatomáceas nos sedimentos, elas determinam, portanto o conteúdo de sílica biogênica. Conclui-se que esta sílica reflete a ressurgência na camada superficial.

Assim, na margem da Somália, variações no fluxo de sílica biogênica como os inferidos a partir de registros sedimentares podem ser usados como um indicador de mudanças na intensidade dos eventos de páleo-ressurgência.

E. Koning et al. / Deep-Sea Research I 48 2474 (2001) 2473–2495



Imagem AVHRR/NOAA-14
18 AGO 1997 - 17:50 GMT

TEMPERATURAS



TEMPERATURA SUPERFICIAL DO MAR

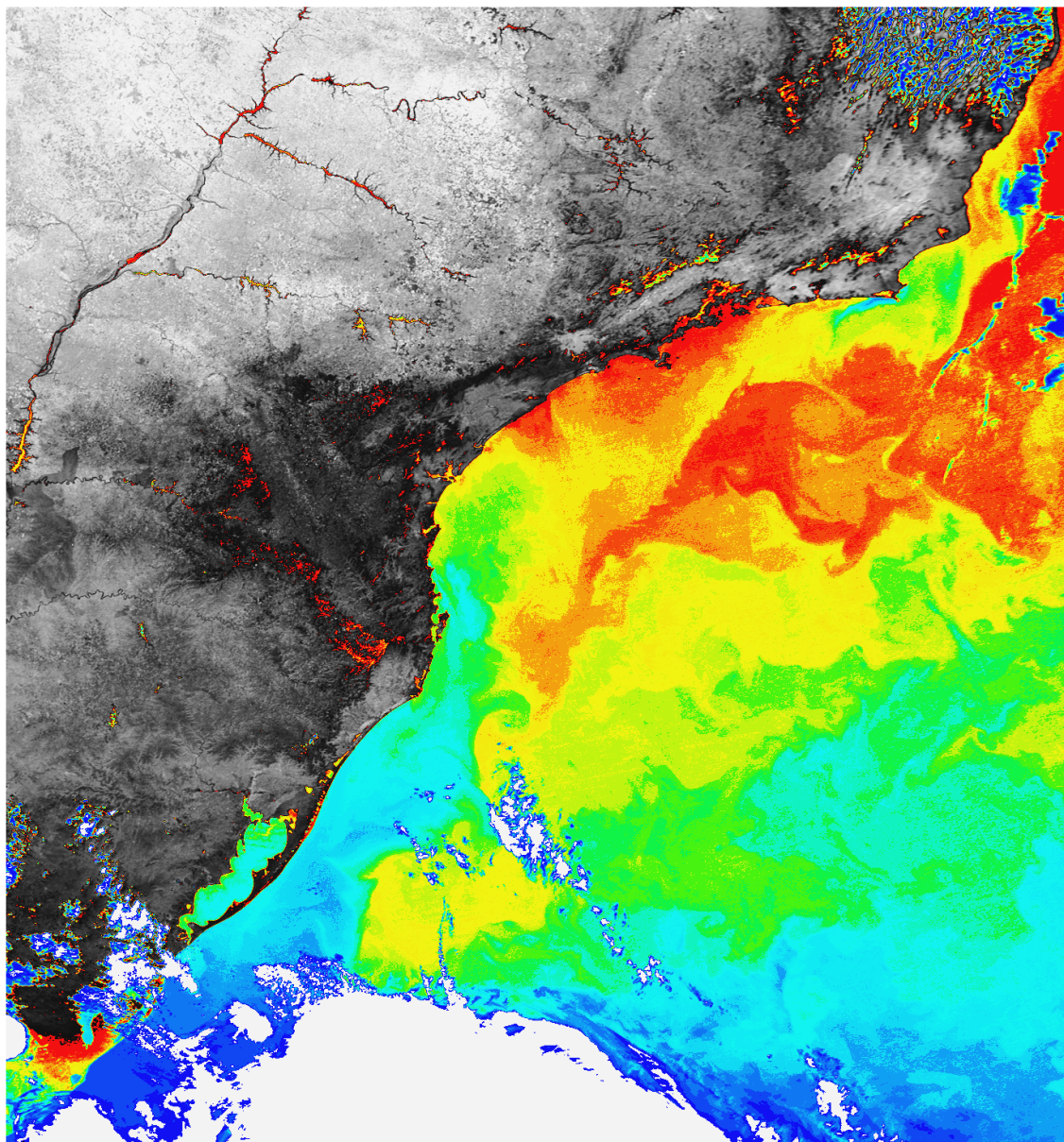
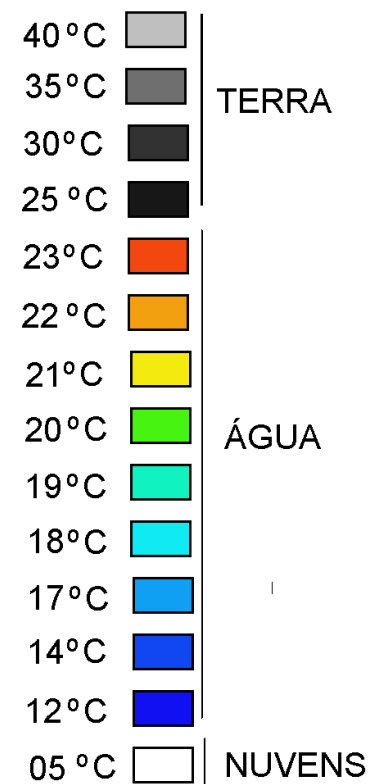
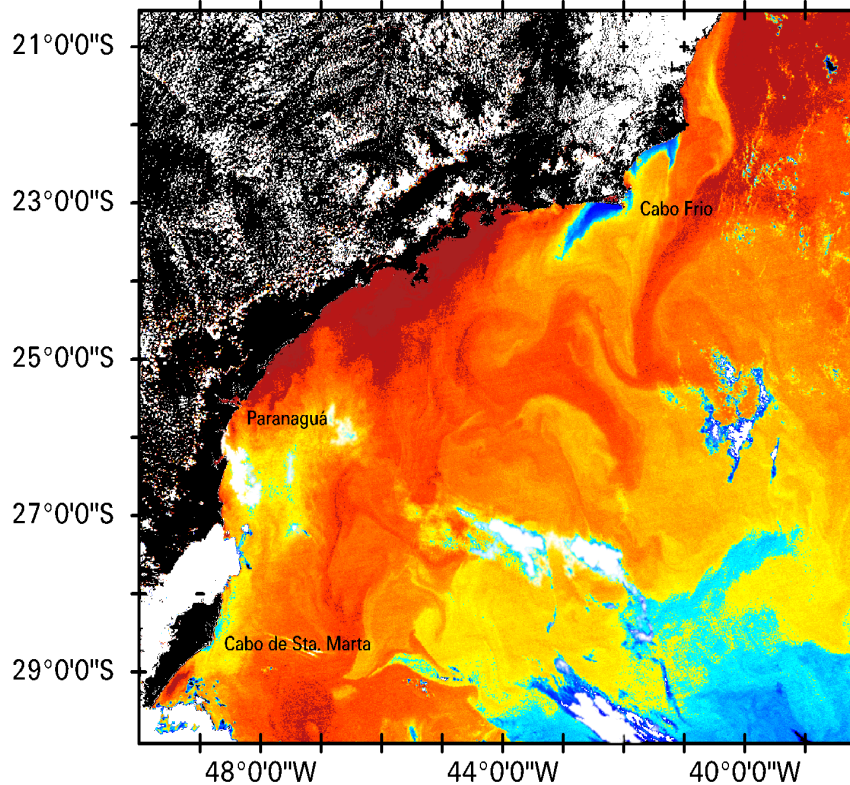

TEMPERATURA (°C)

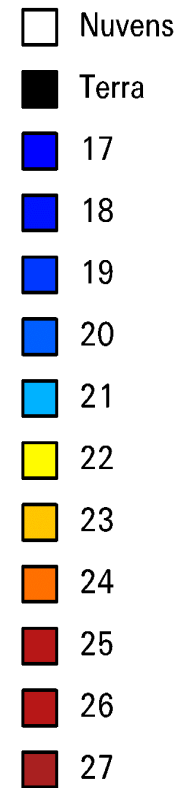

Escala

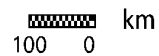

SENSOR/SATÉLITE: AVHRR/NOAA-14

ALGORITMO: DAYTIME NLSST

AQUISIÇÃO: 07/11/95 - 16:54 GMT

REGIÃO CENTRAL DA BACIA DE SANTOS

CONVÊNIO PETROBRÁS/FURG

A ressurgência de Cabo Frio

C.A.A.H. Carbonel / Continental Shelf Research 23 (2003) 1562–1578

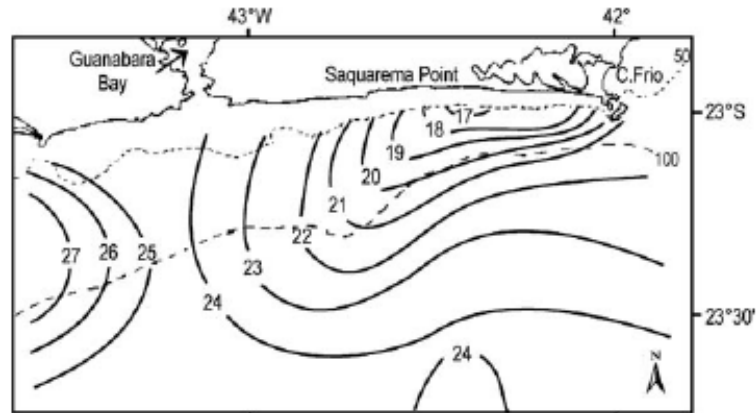

(a)

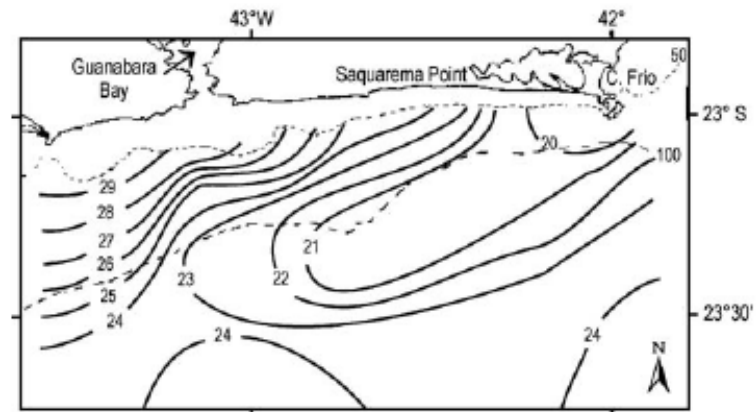

(b)

Fig. 2. SST ($^{\circ}$ C) observed in: (a) the first survey from 4 to 6 February 1971; and (b) second survey from 10 to 13 February 1971 (From Magioca et al., 1979).

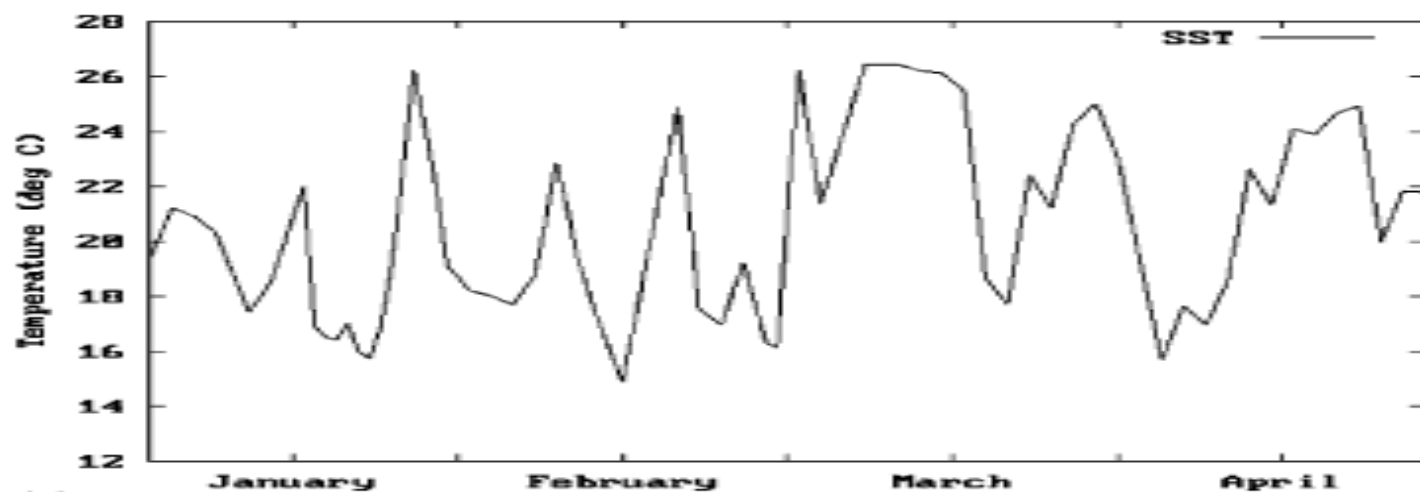

(a)

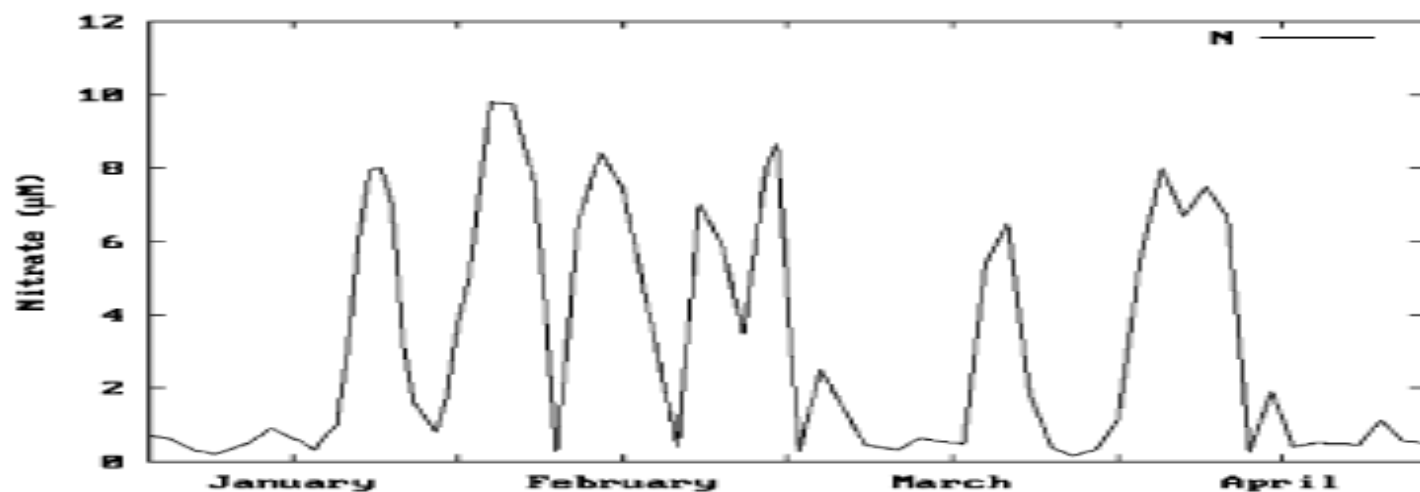

(b)

Fig. 4. Variability of SST and nitrate (N) at the marine station of Cabo Frio, during the period January–April 1973.

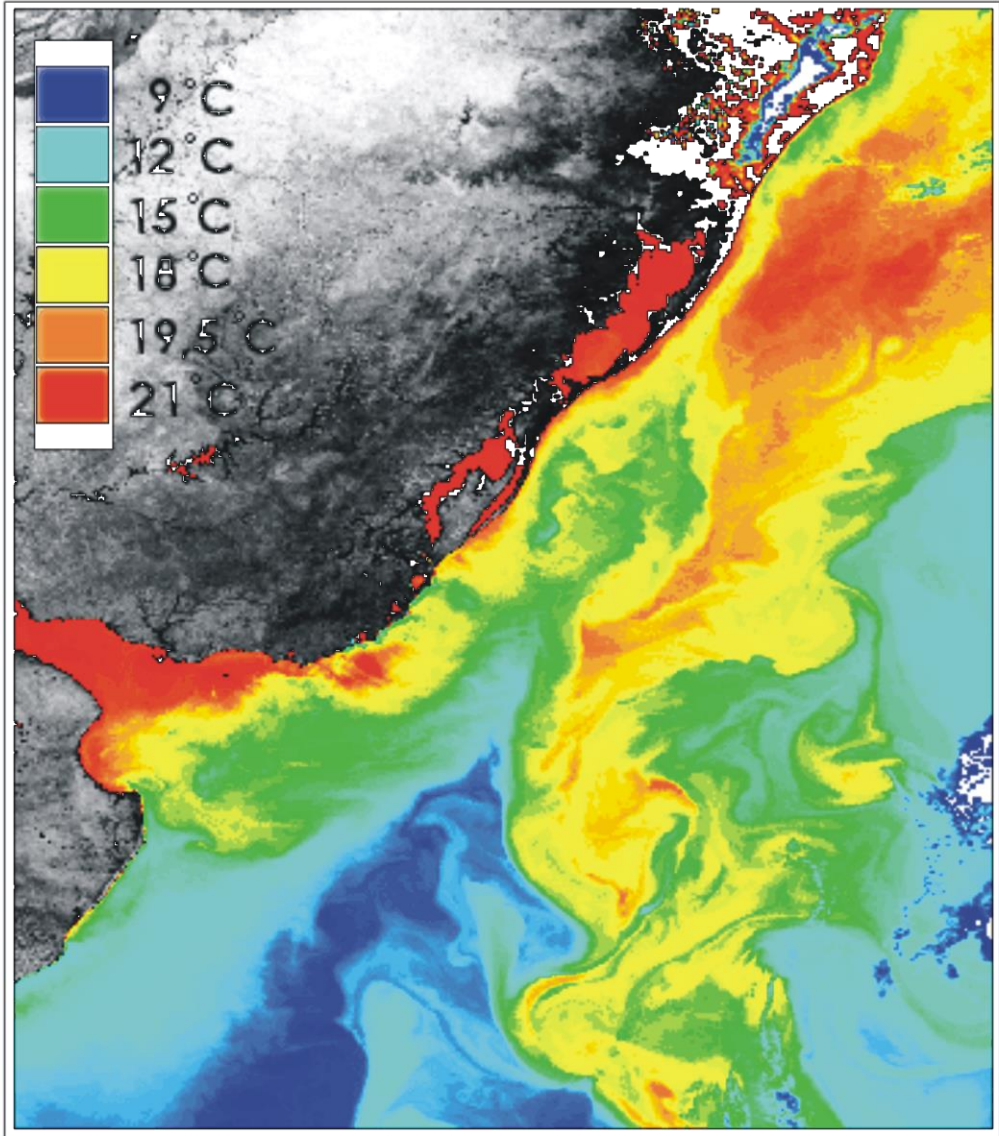

Variabilidade sazonal

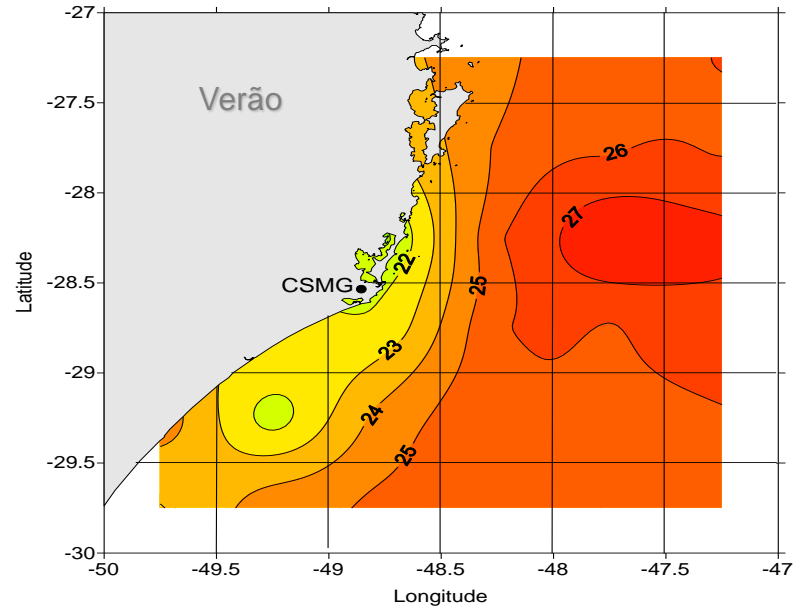
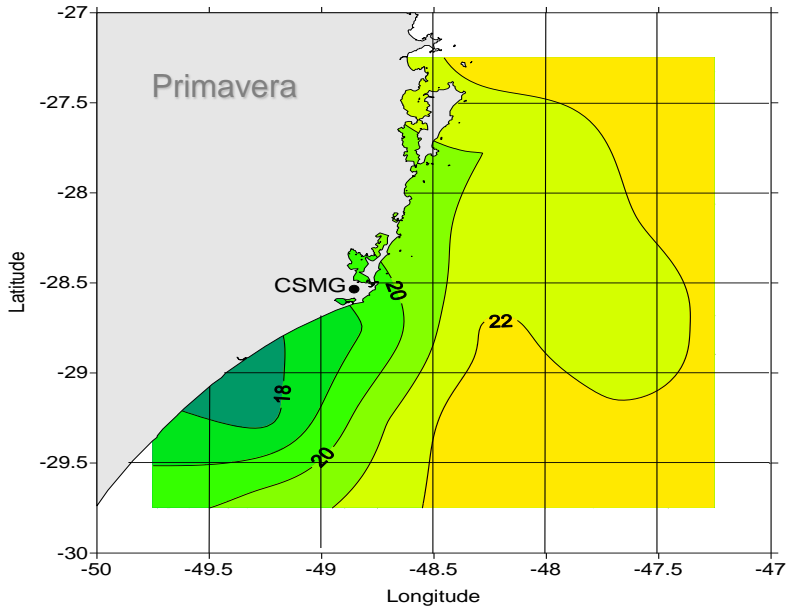

Temperatura (°C)

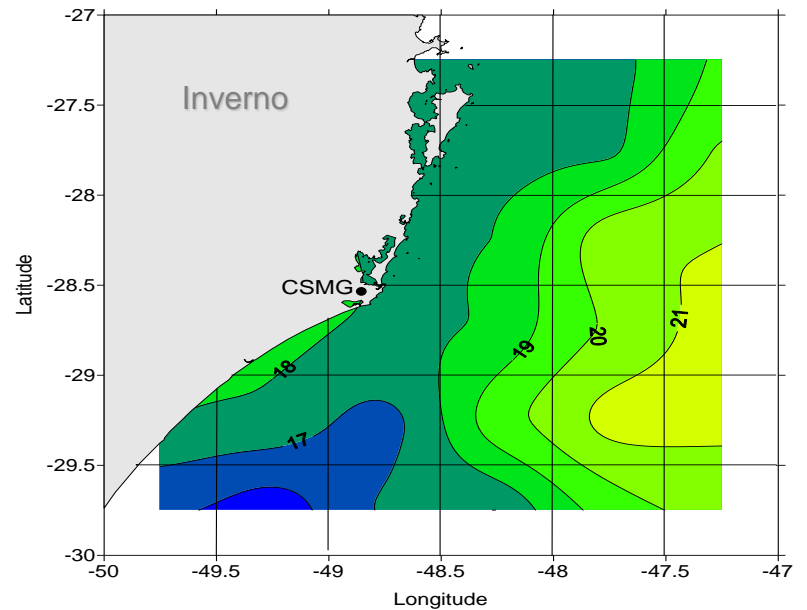
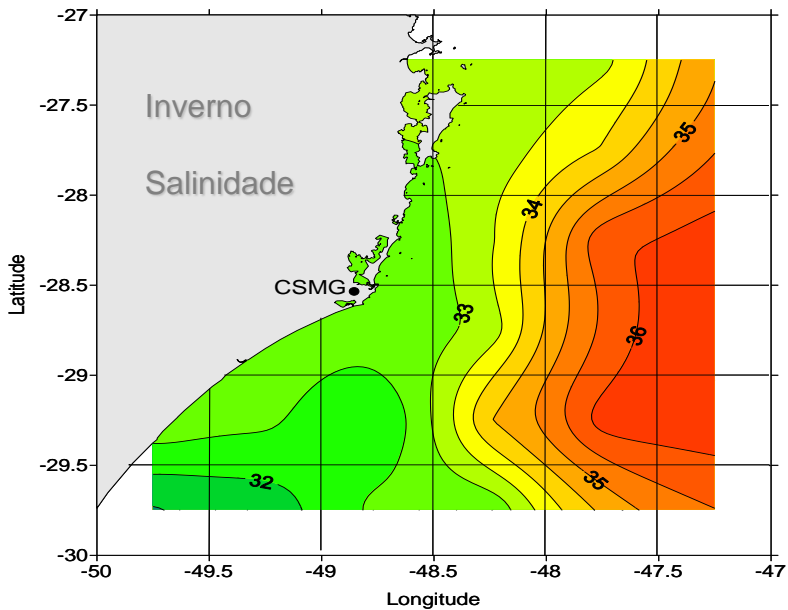

Resultados

Dados históricos

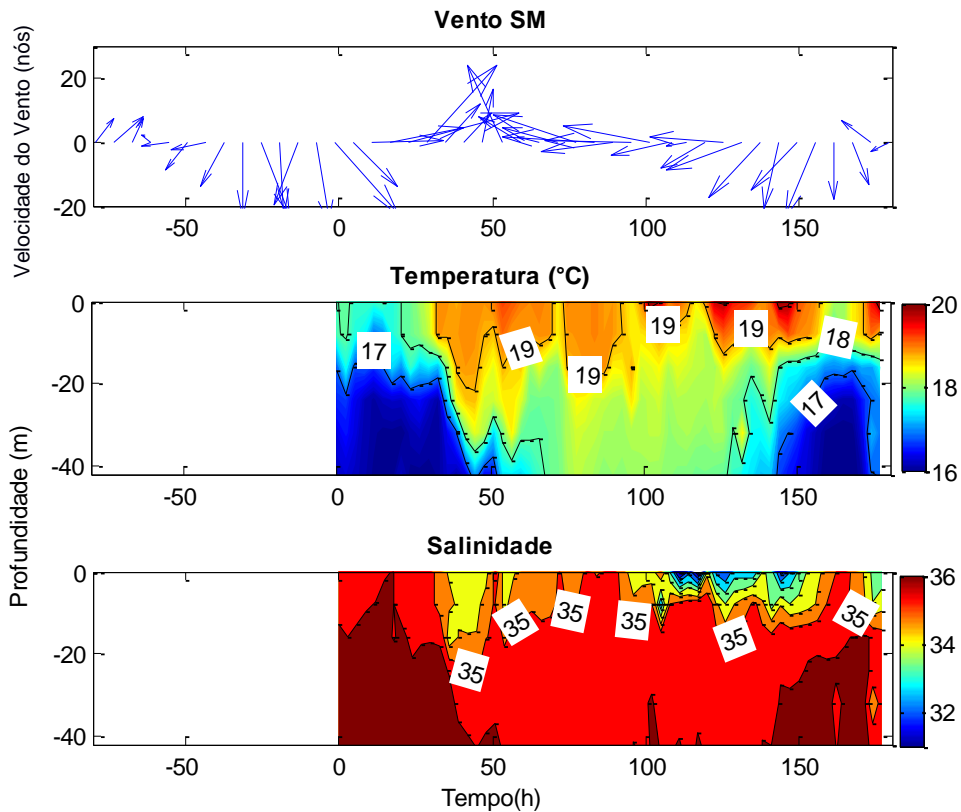

Velocidade vertical estimada a partir do deslocamento da isoterma de 17°C variou de $3 \times 10^{-4} \text{ m.s}^{-1}$ no primeiro evento a $8 \times 10^{-4} \text{ m.s}^{-1}$ no segundo

Quando o processo de ressurgência relaxa, águas de baixa salinidade se aproximam da costa.

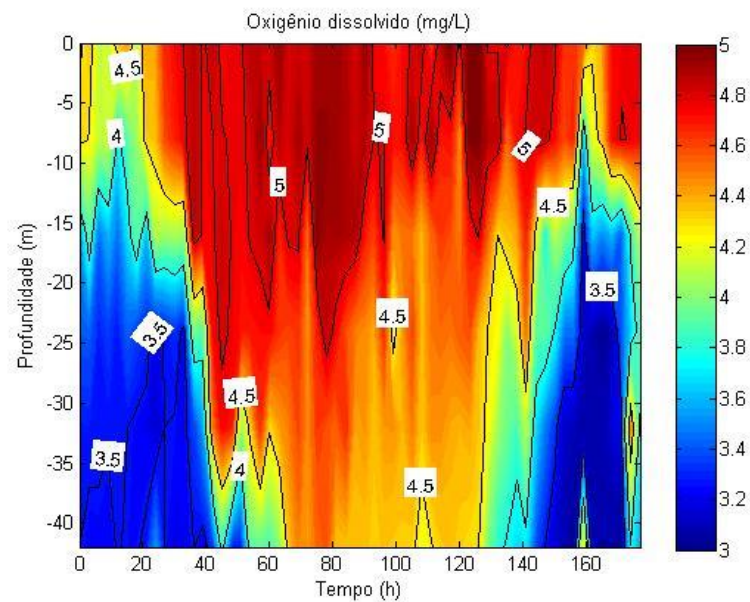
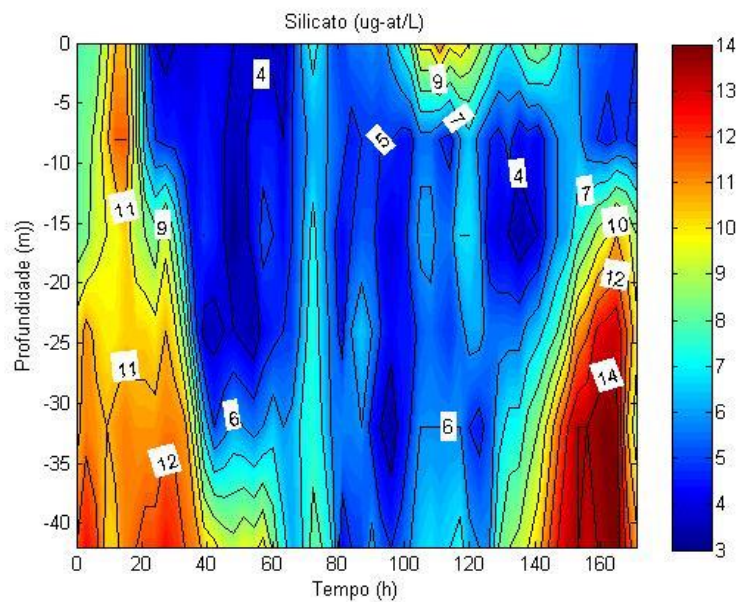
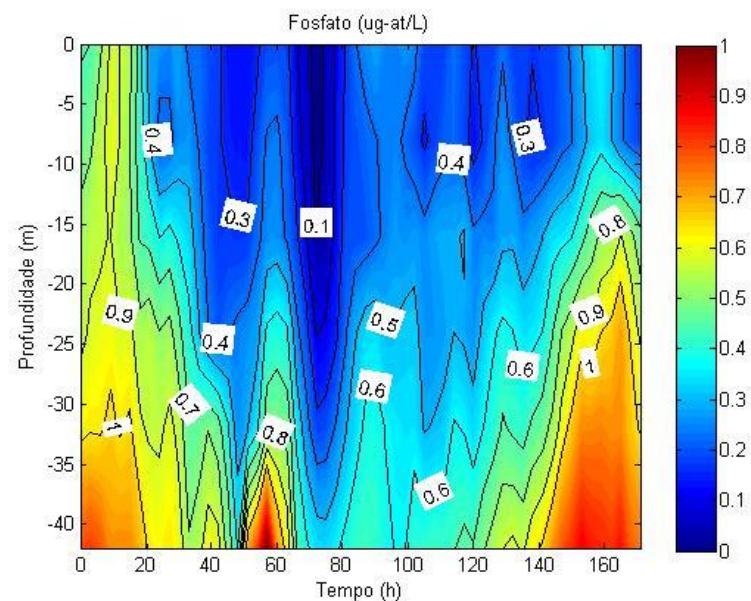
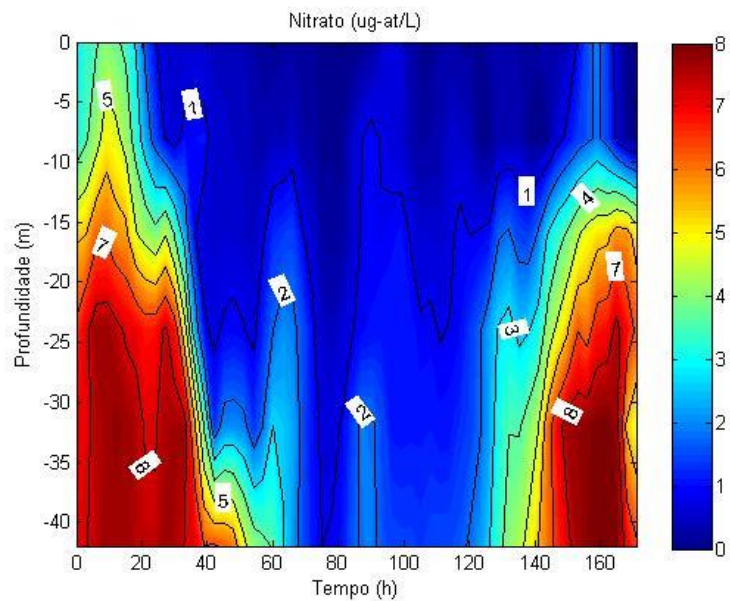

Resultados – Datos Recientes

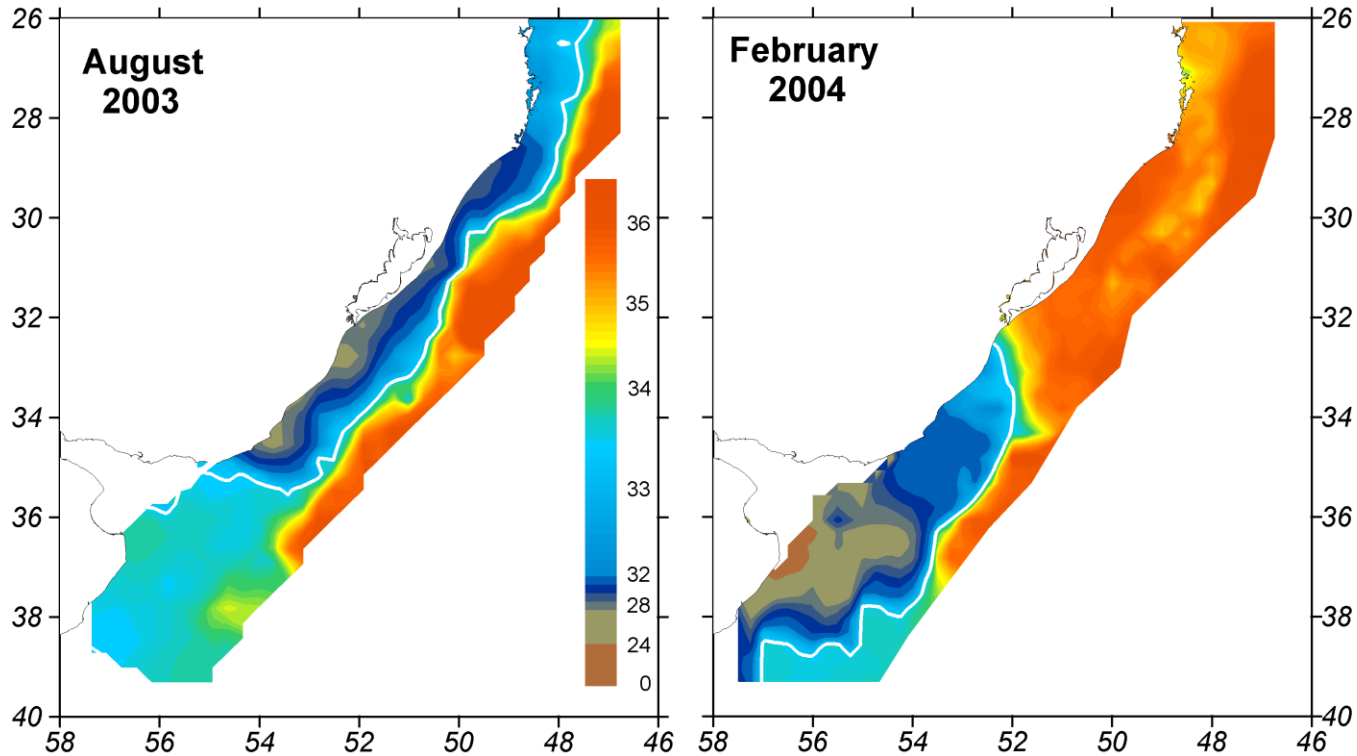

Resultados - Dados Recentes

Cruzeiro La Plata Fev/2004

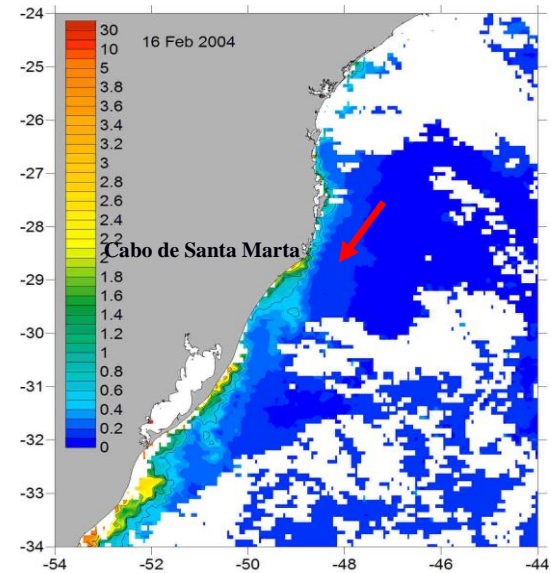
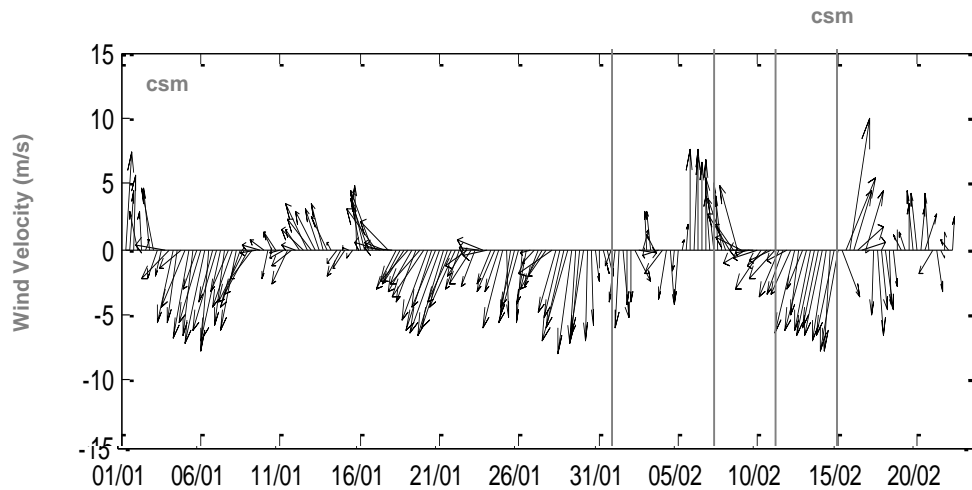
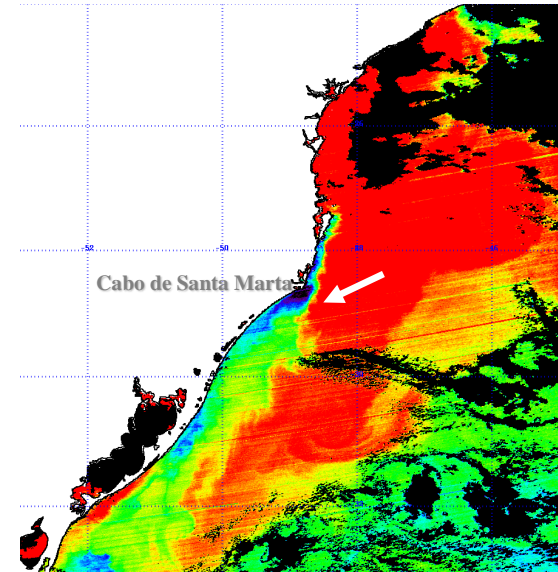
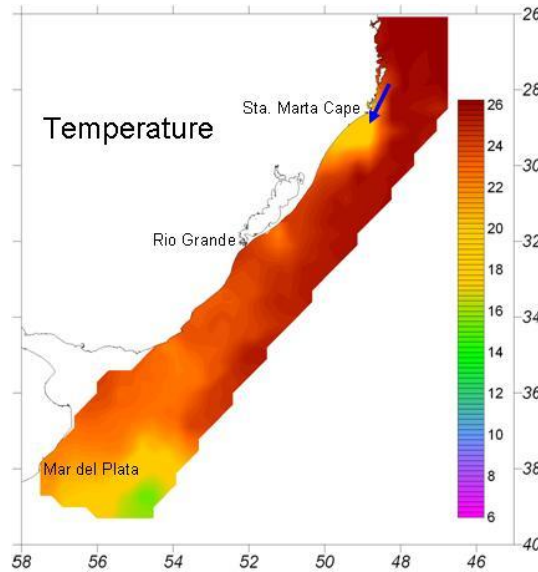

Dados Cruzeiro La Plata

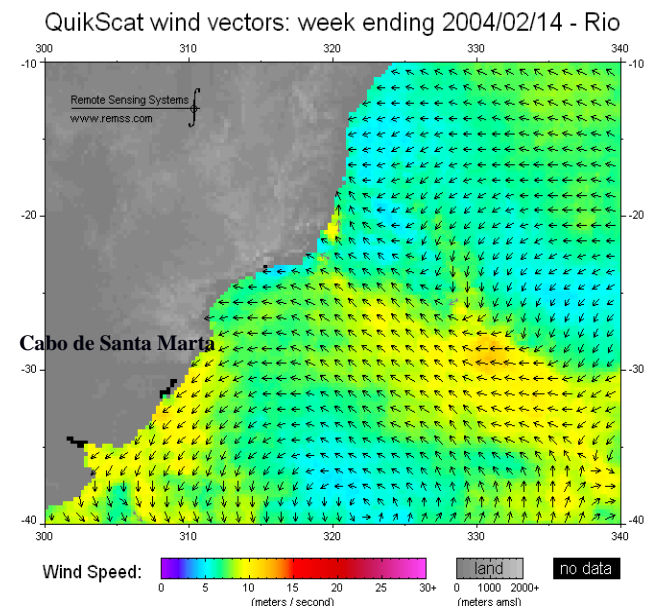
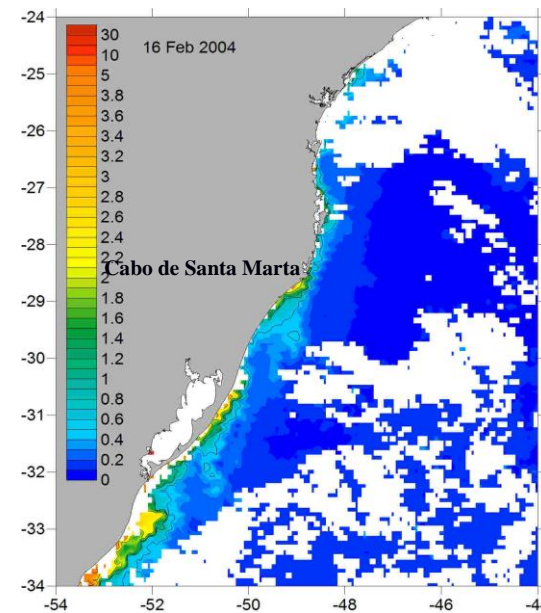
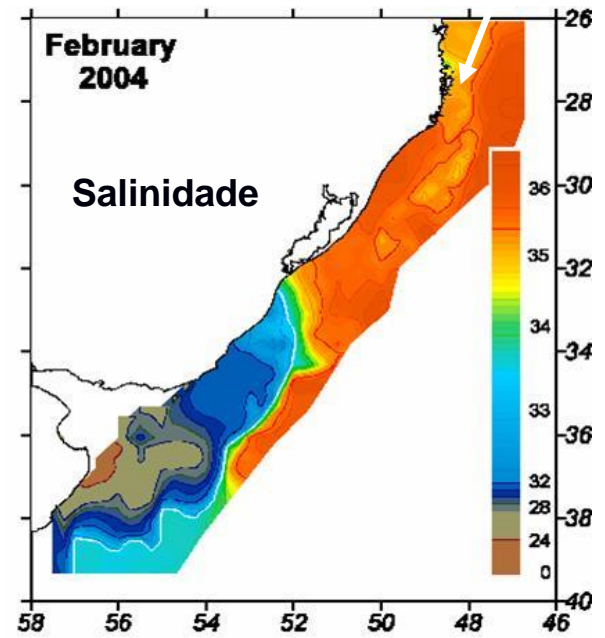
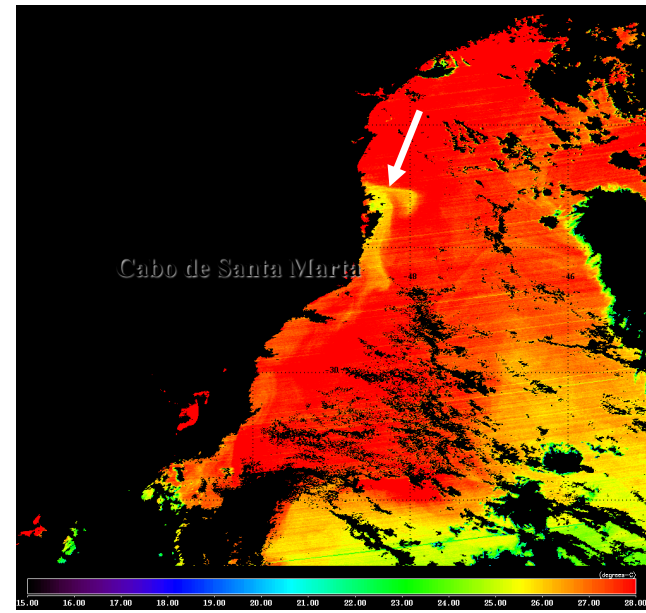
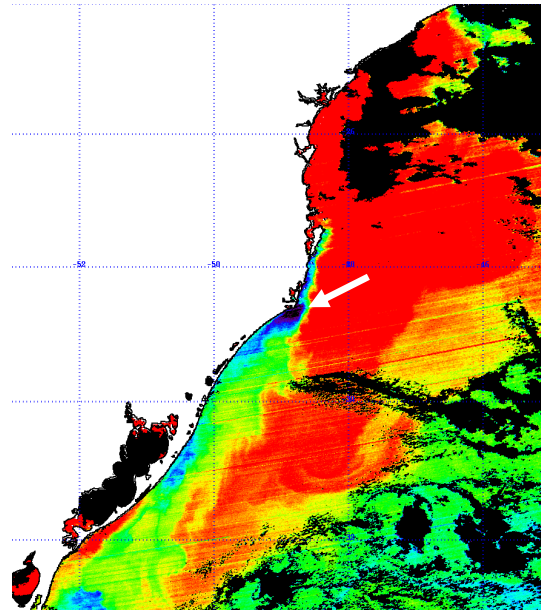
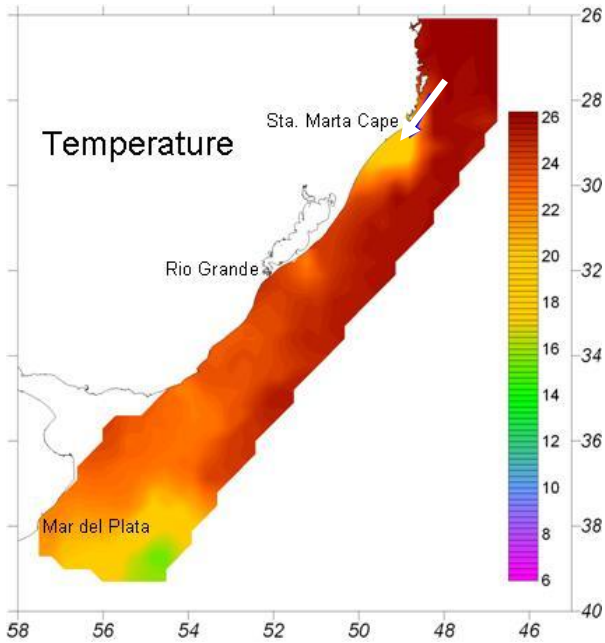

Santa Marta - Summer

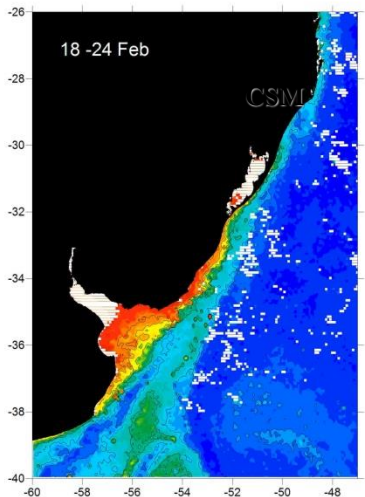
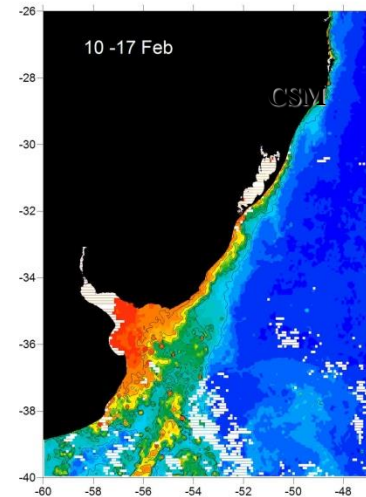
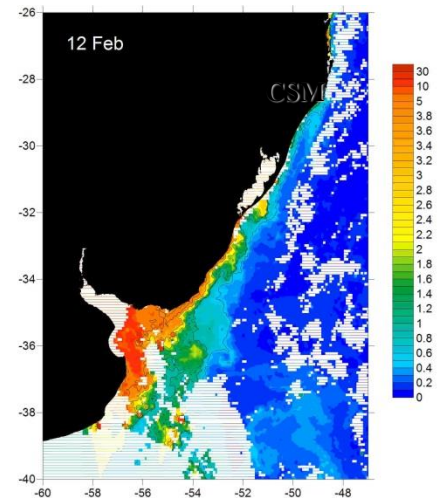
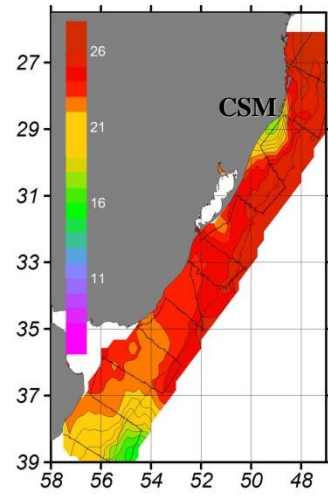
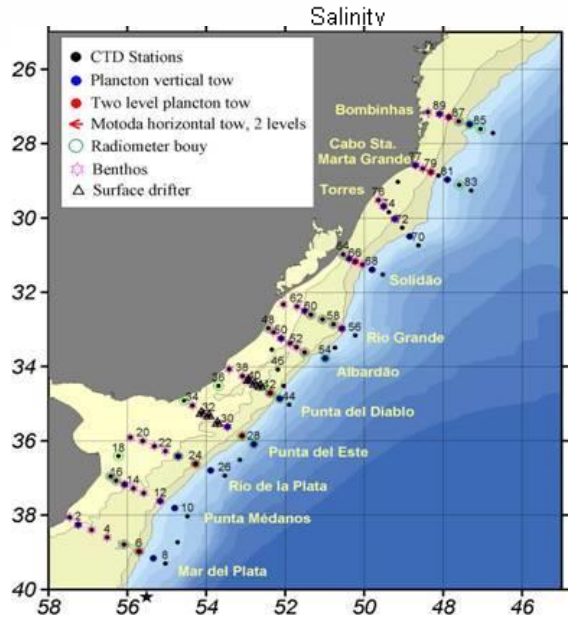
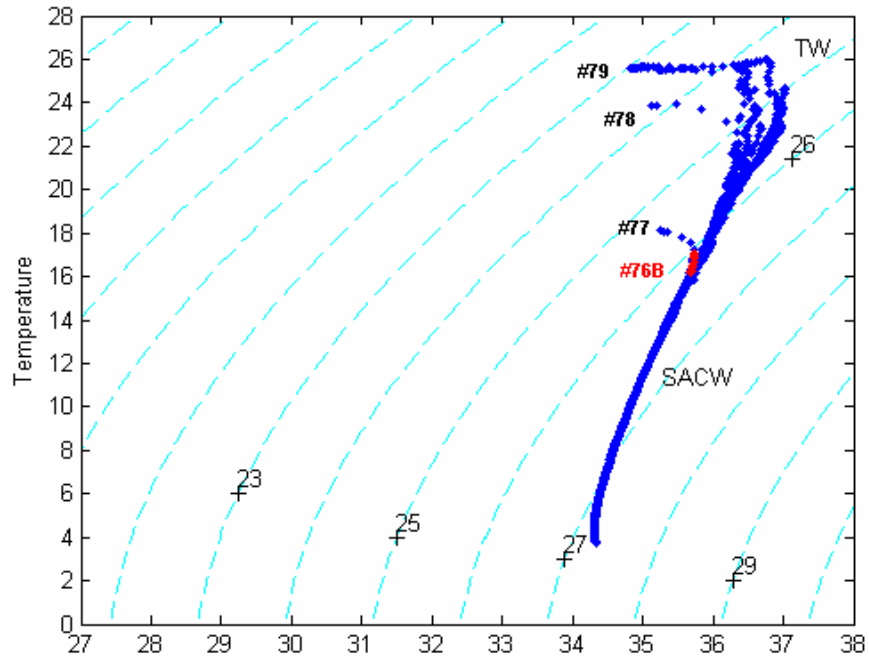

Ventos

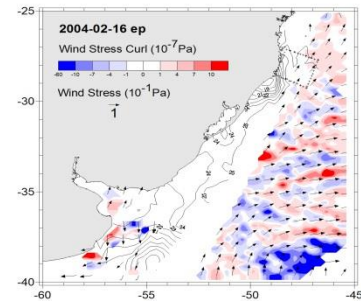
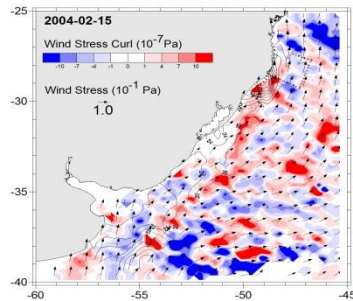
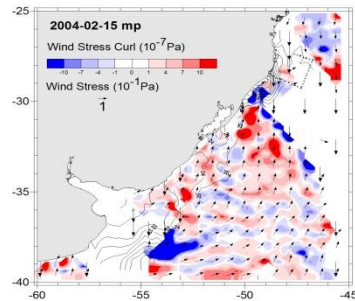
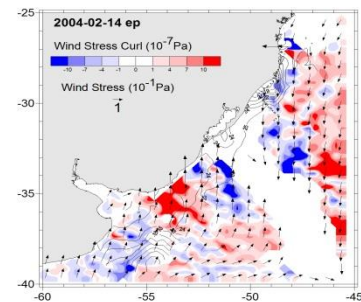
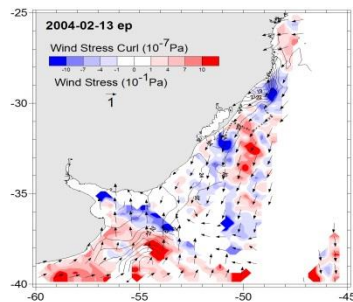
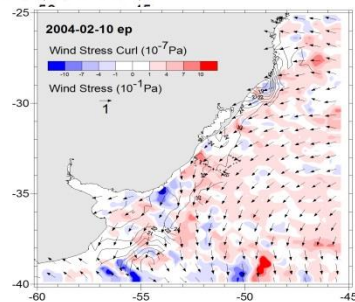
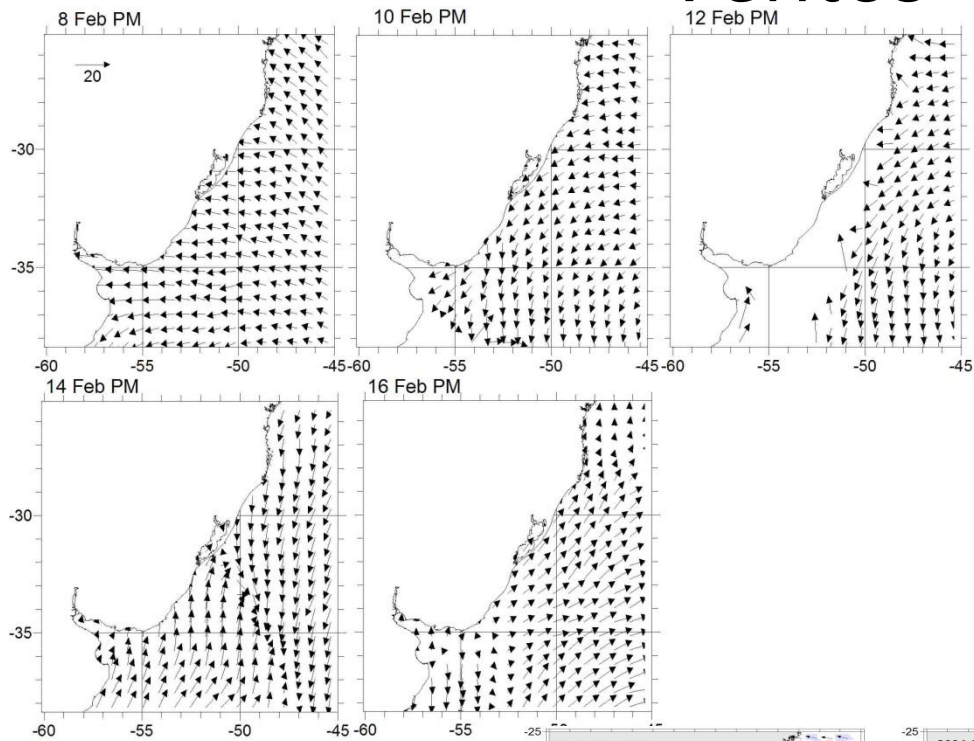

E s t r u t u r a V e r t i c a l

< - Inverno - Verão - >

Temperatura

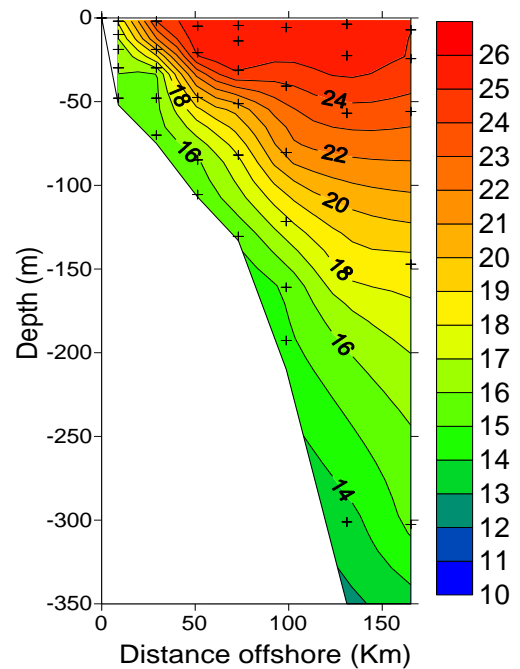
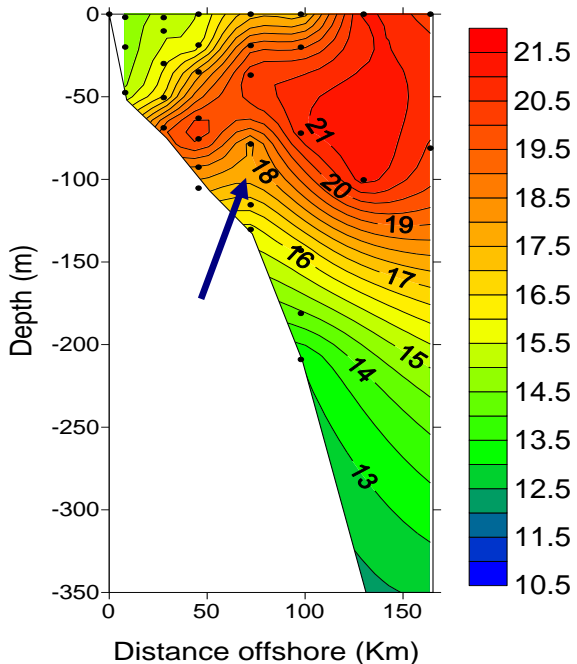

Salinidade

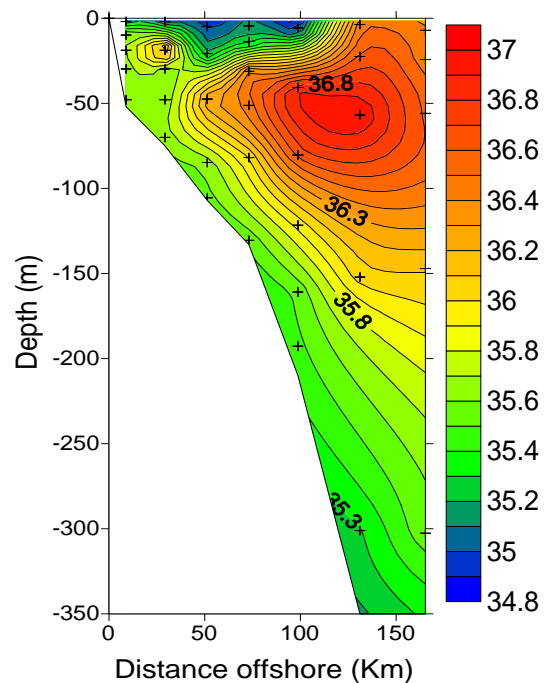
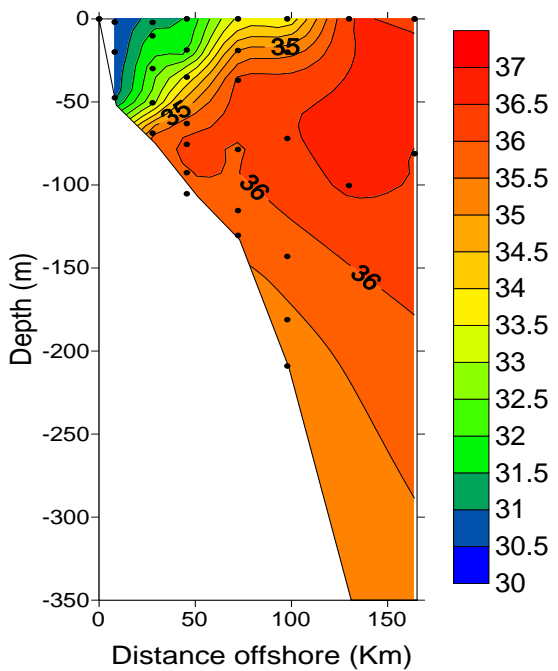

< - Inverno - Verão - >

Nitrato

Silicato

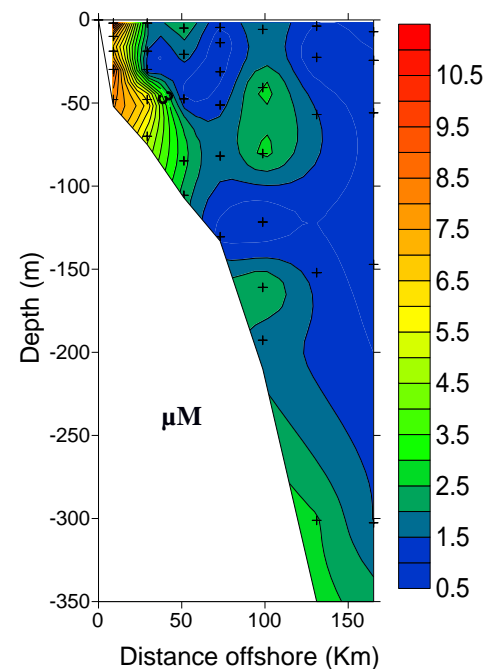
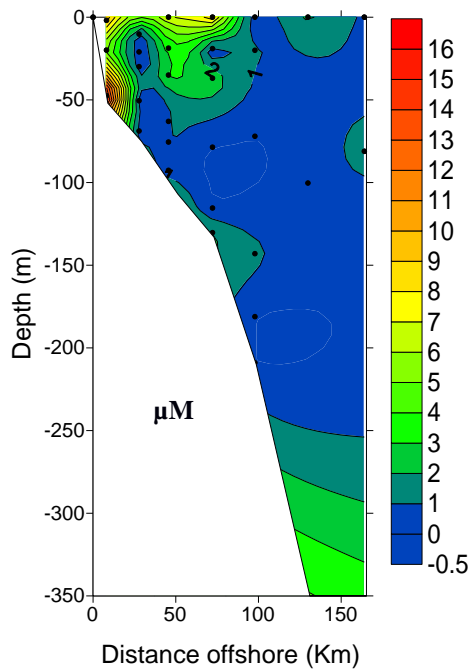
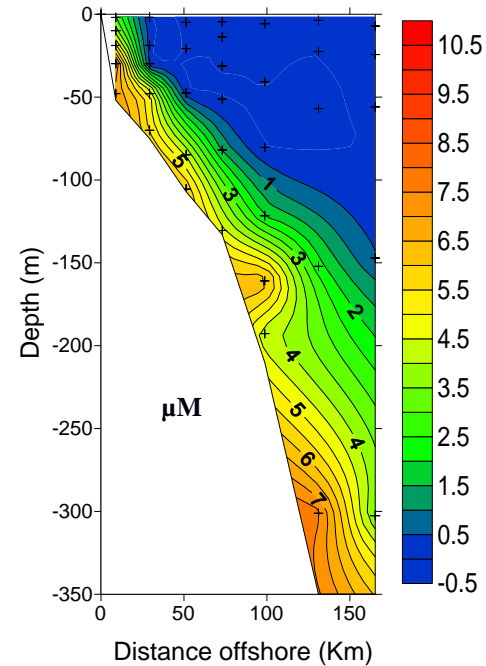
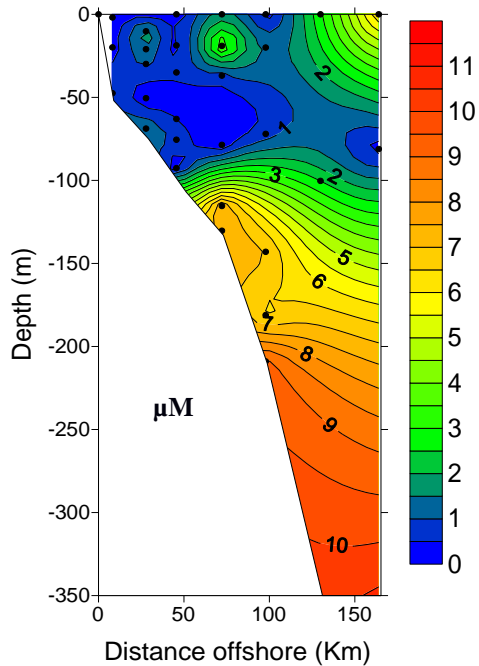

< - Inverno - Verão - >

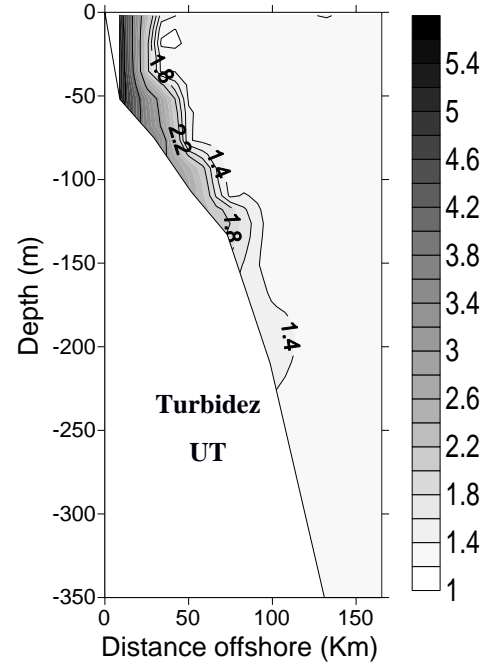
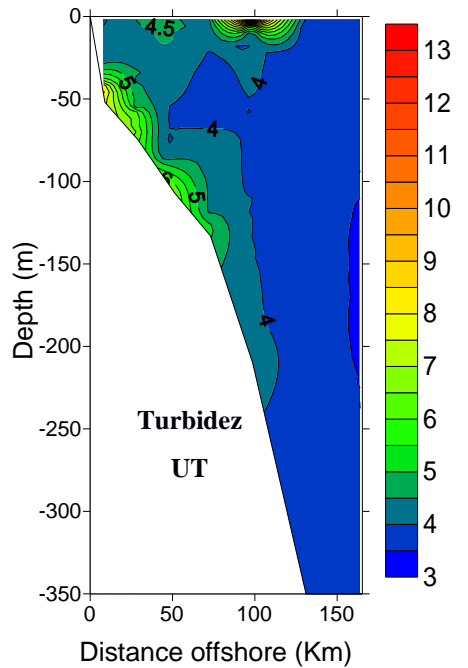
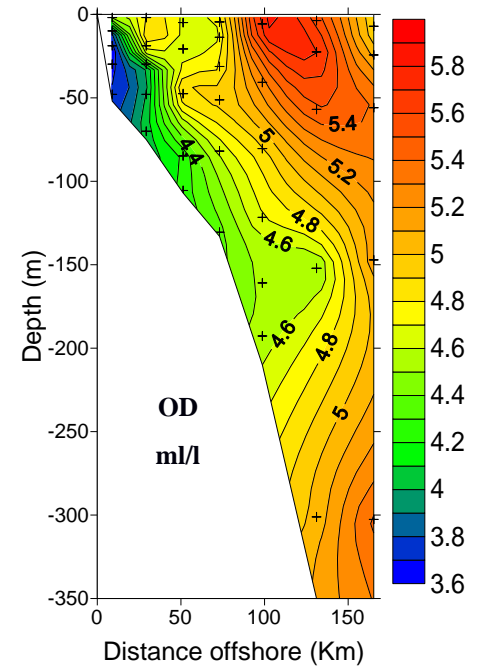
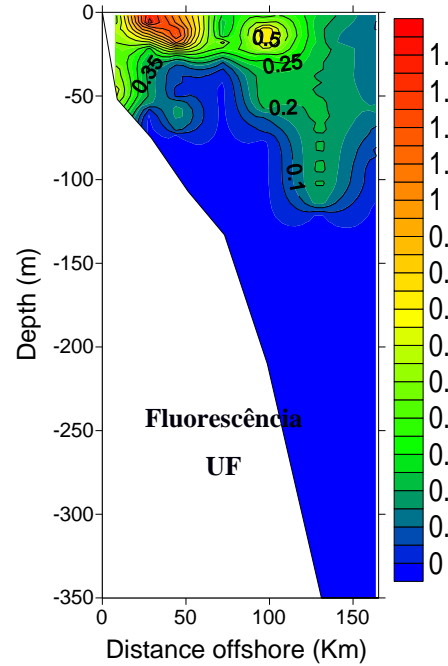
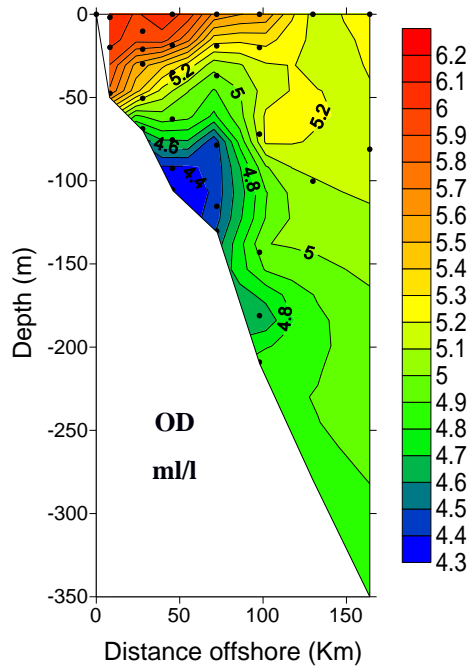

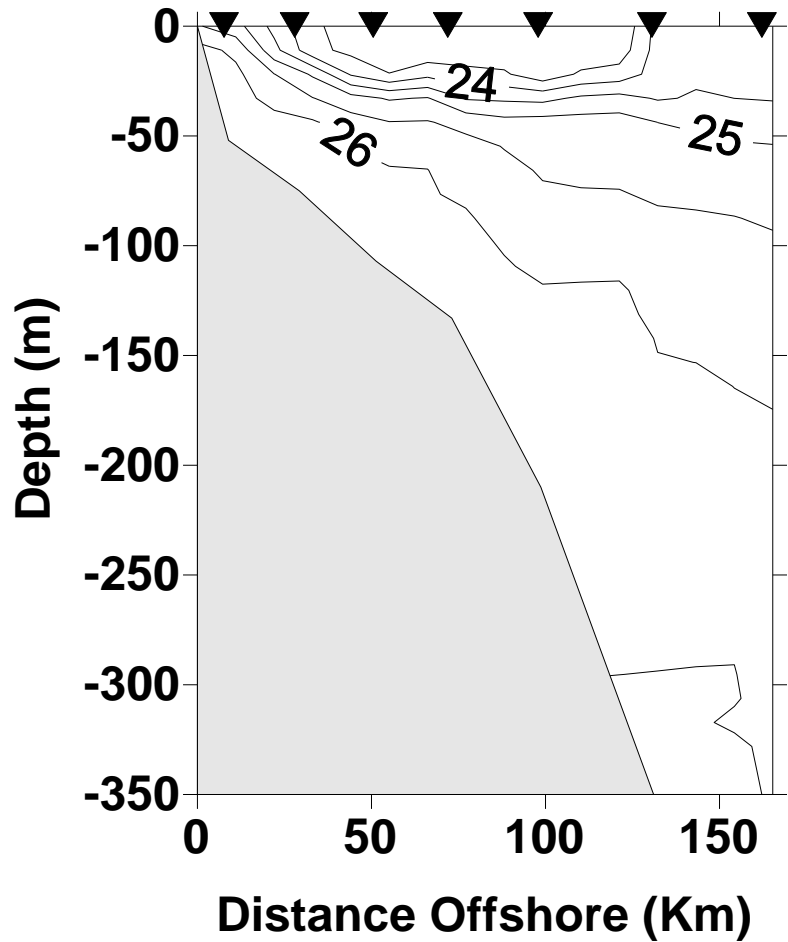
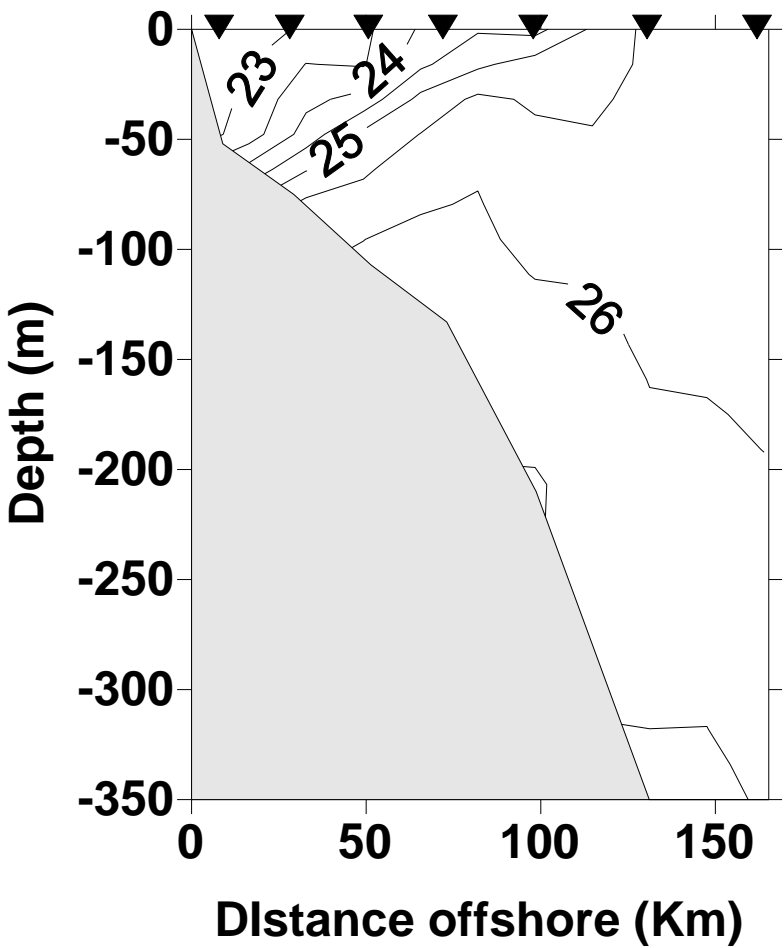

Conclusões

A ressurgência do CSM:

É um processo que ocorre em pulsos que são associados ao ritmo de passagem de frentes meteorológicas pela área.

Depende do tempo de duração em que ventos de NE/N soprem sobre a região.

Em função do regime de ventos, a maior probabilidade de ocorrência é nos meses de primavera e verão .

O modelo de circulação sazonal da área segue o proposto por Campos et al. (1995). ----->

No inverno AC (PRP) e AT da Corrente do Brasil separam ACAS da costa.

Eventos de ressurgência de quebra de plataforma podem ocorrer no inverno.

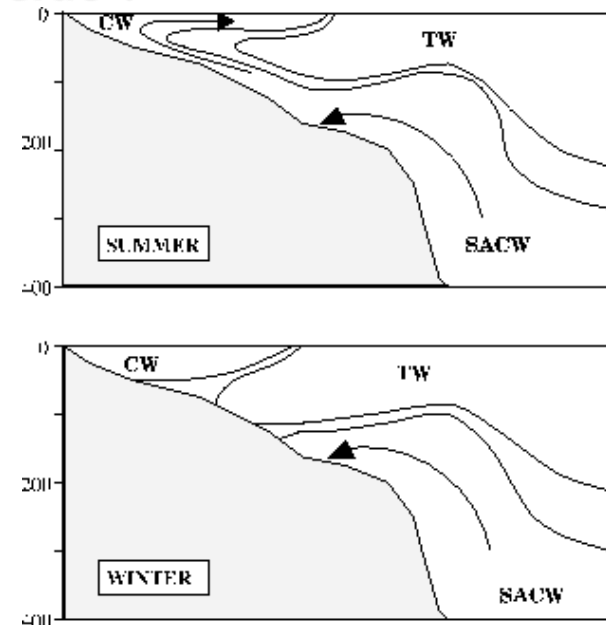

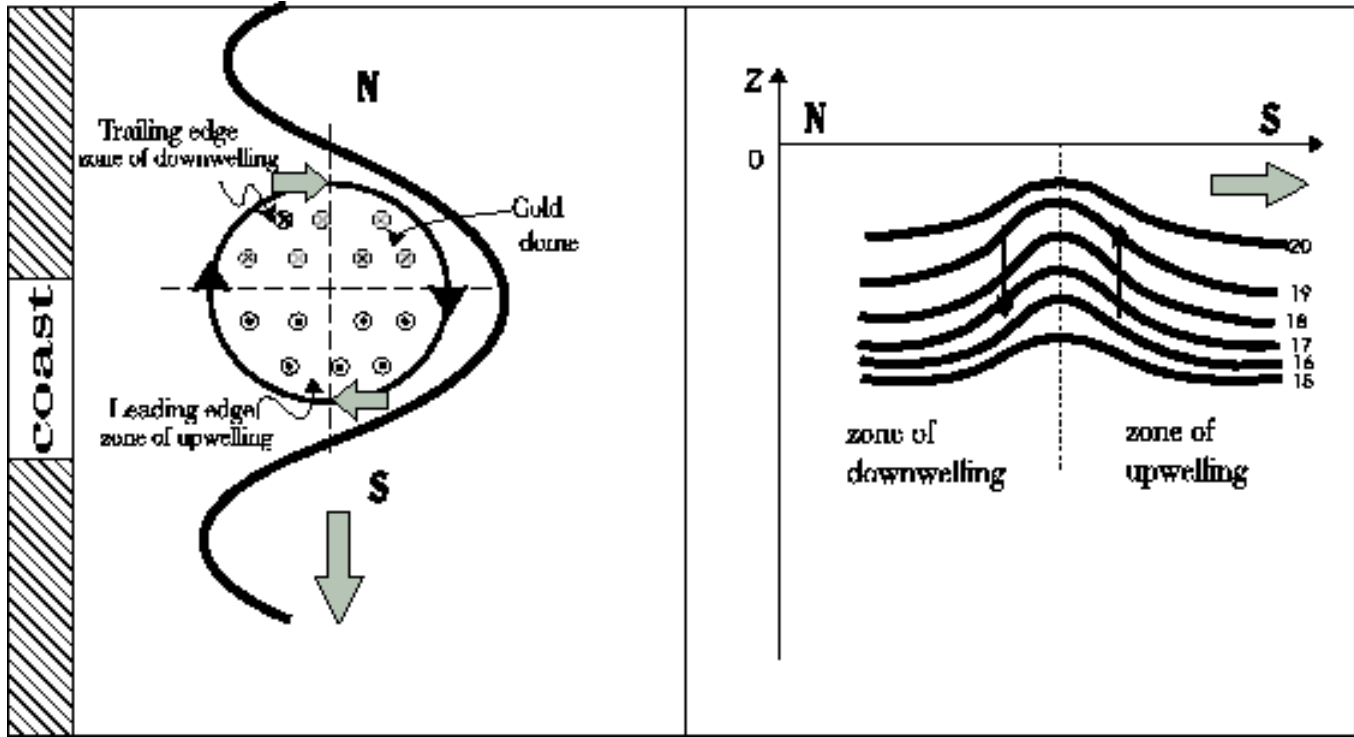

Conclusões

No inverno, máximos de superficiais de Silicatos, Turbidez e Fluorescência ocorrem na PRP e na área da FSTP. Próximo ao fundo, os máximos de Silicatos e de Turbidez podem estar ligados à turbulência.

No verão, o processo de ascensão de águas injeta nutrientes na camada superficial, entretanto a área afetada é muito restrita quando comparada à situação de inverno.

Pergunta: a ressurgência é realmente importante para a produção biológica da área do CSM?

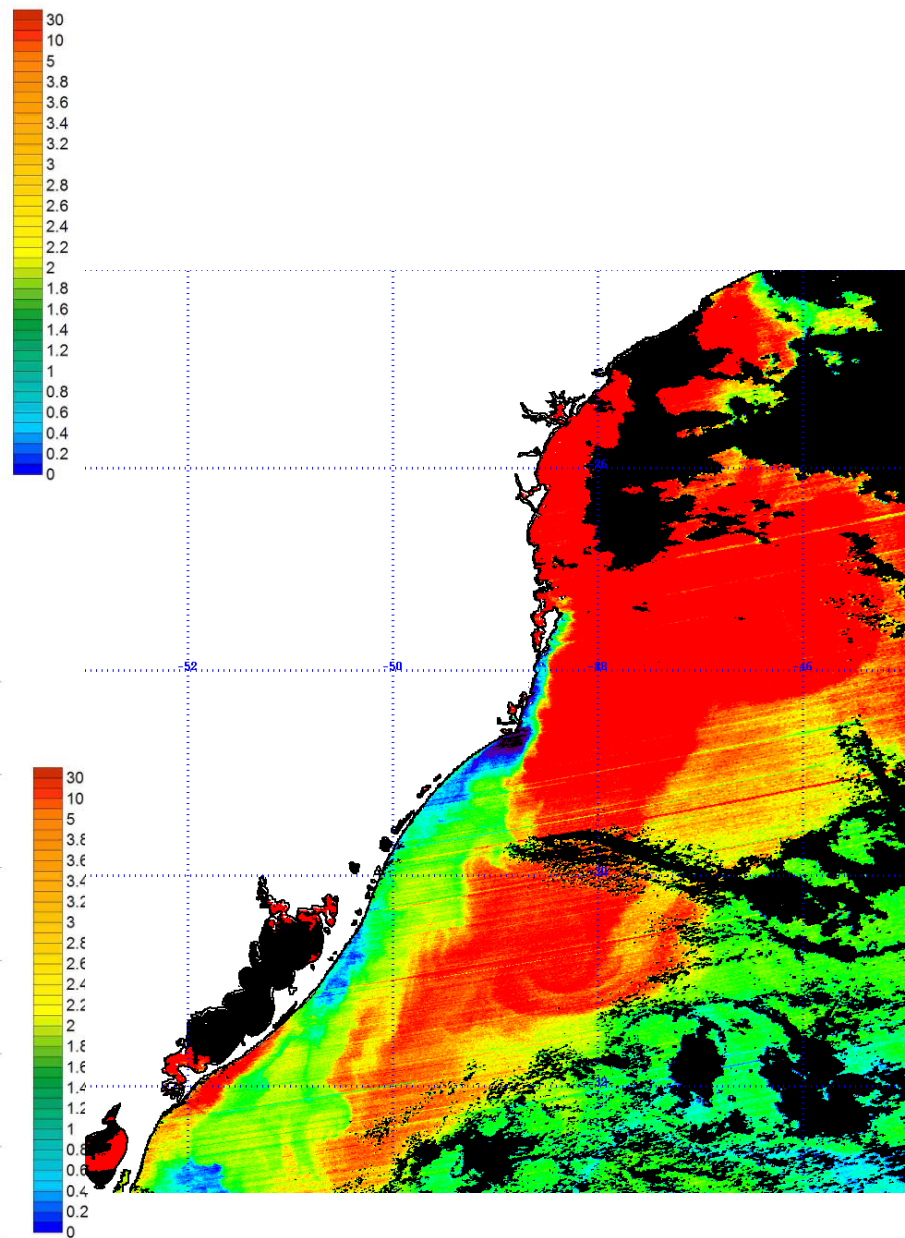
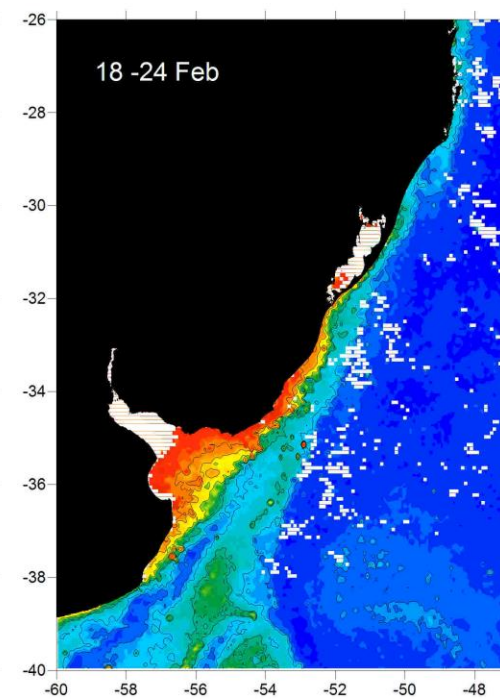
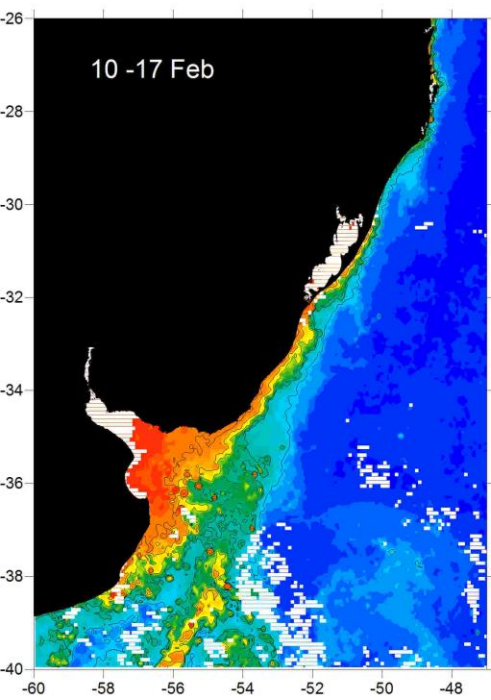
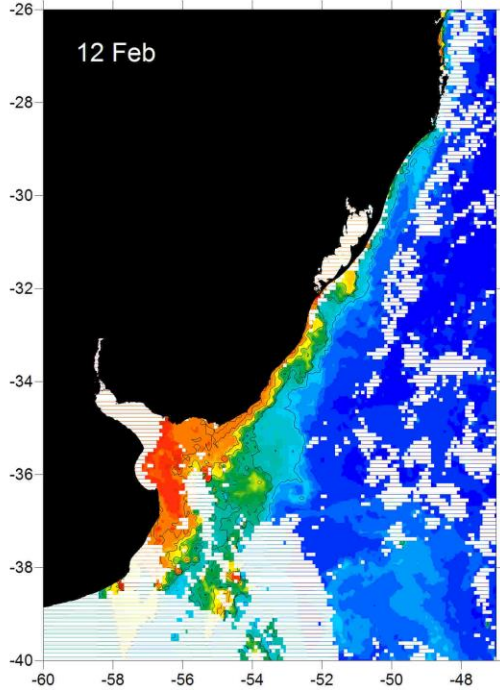
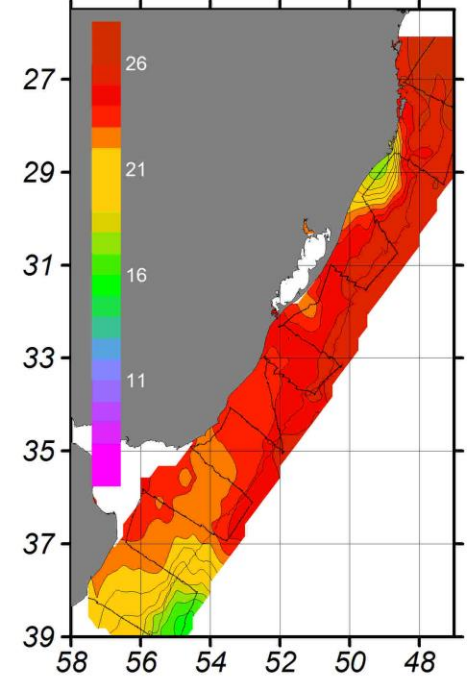

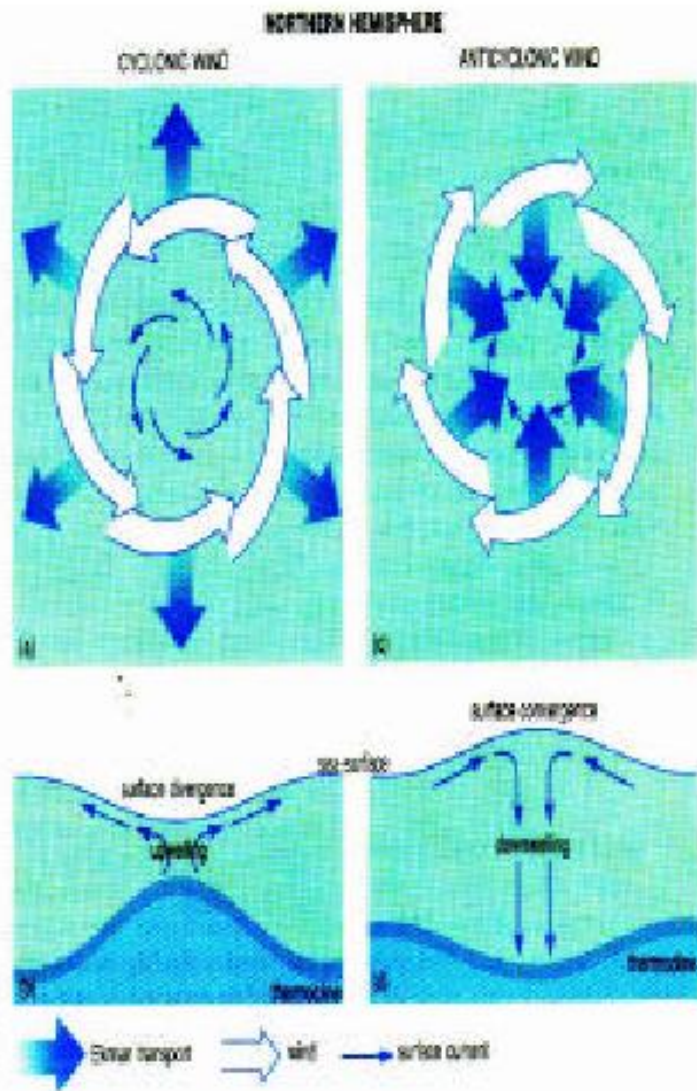
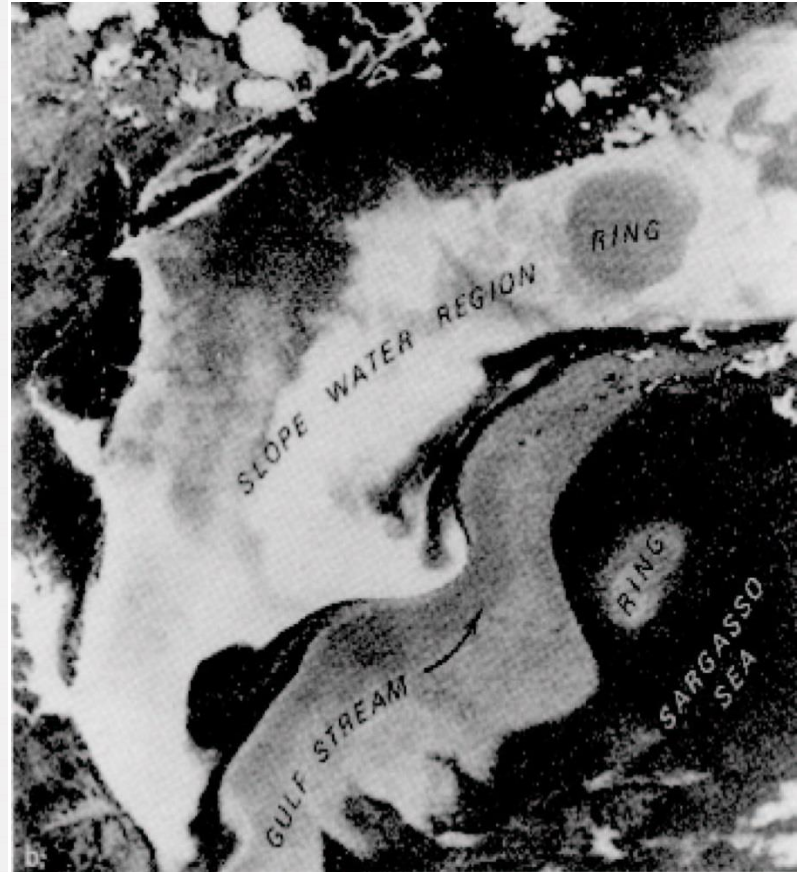
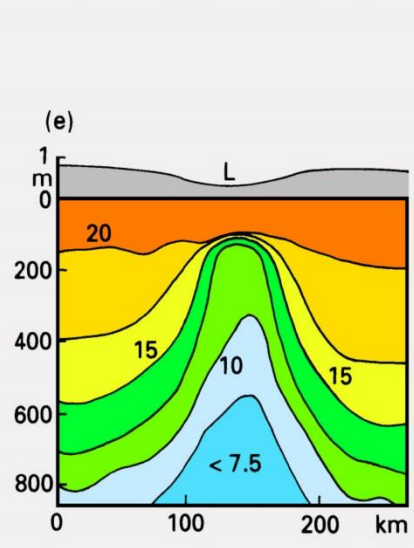
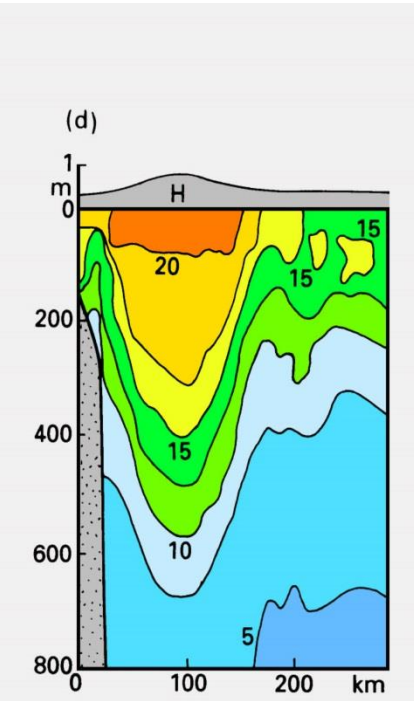
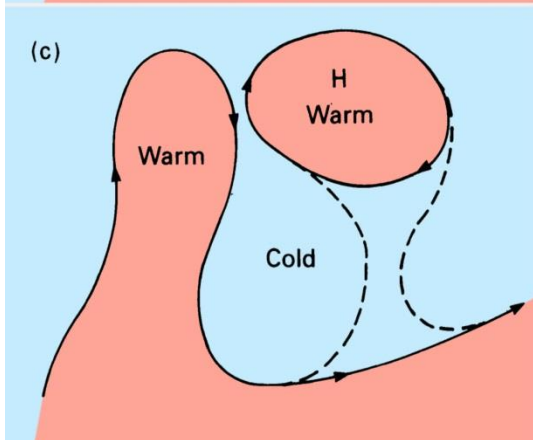
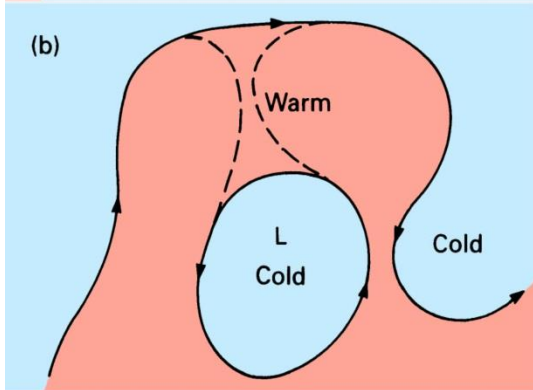
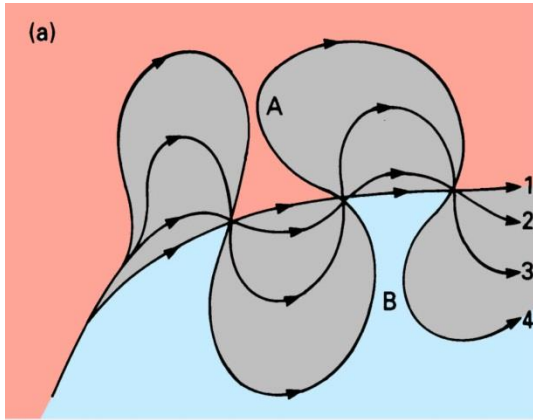
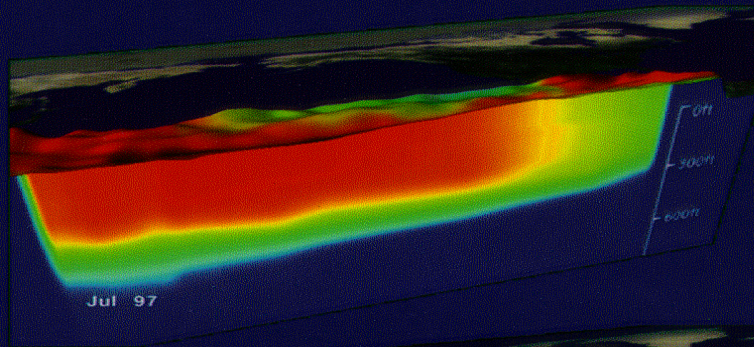
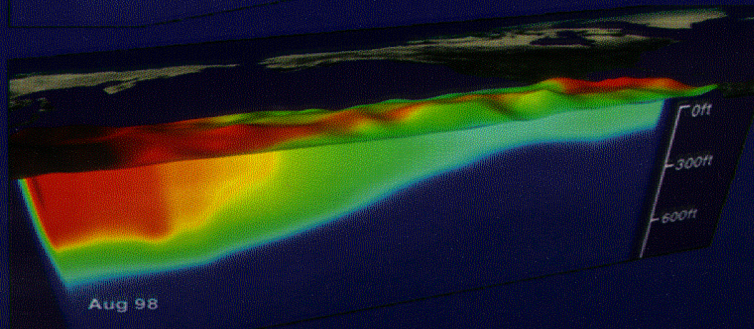

Figure 3.25 The effect of a cyclonic wind in the Northern Hemisphere (a) on surface waters, (b) on the shape of the sea surface and thermocline. Diagrams (c) and (d) show the effects of an anticyclonic wind in the Northern Hemisphere.





July '97



Aug '98